

The Power of Full Scale.

EFNOTE 7





Quickstart Guide



EN

Hello!

Contents

IMPORTANT SAFETY INSTRUCTIONS	4
Important Information	5
Assembling	6
Packing List	6
Assembly	7
Adjusting the Side-Rim Position	9
Attaching the Beater Patch	9
Tuning the Head Tension	9
Connection	10
Basic Operation	12
Panel Description	12
Power On/Off	12
Home Screen	13
 Volume	13
 Inst Info	13
 Click (Metronome)	13
 Recorder	13
 Menu	14
Power Menu	14
Changing the Instrument	15
Adjusting the Pad Levels	15
Connecting Your Smart Device with Bluetooth	16
Changing the Power Save Setting	17
Adjusting the Hi-Hat (Auto Calibration)	17
Specifications	18
Optional components and consumable parts	19
Support	19

For the EFNOTE 7 Reference Guide, optional components, or other latest information, please refer to the EFNOTE 7 website.

ef-note.com/products/drums/EFNOTE7/efnote7.html





IMPORTANT SAFETY INSTRUCTIONS



FAILURE TO OBSERVE THE FOLLOWING SAFETY INSTRUCTIONS MAY RESULT IN FIRE, ELECTRIC SHOCK, INJURY TO PERSONS, OR DAMAGE TO OTHER ITEMS OR PROPERTY.

You must read and follow these instructions, heed all warnings, before using this product. Please keep this guide for future reference.

About warnings and cautions

 WARNING	Indicates a hazard that could result in death or serious injury
 CAUTION	Indicates a hazard that could result in injury or property damage

About the symbols

	"Caution": Calls your attention to a point of caution
	"Do not ..": Indicates a prohibited action
	"You must ..": Indicates a required action

WARNING

To reduce the risk of fire or electric shock, do not expose this product to rain or moisture



Do not use or store in the following locations

- Locations subject to water or rain
- Moist or humid locations (near a bath or shower, or on a wet floor)
- High temperature locations (in direct sunlight, near heating equipment)
- Locations subject to salt damage
- Excessively dusty locations



Turn the power off if an abnormality or accident occurs

In the following situations, immediately turn off the power, disconnect the AC adapter from the AC outlet, and contact your dealer.



- If the AC adapter, power cord, or plug is damaged
- If smoke is emitted or an abnormal odor is noticed
- If liquid or a foreign object enters the product
- If an abnormality or malfunction occurs in the product



Do not plug or unplug the AC adapter with wet hands

You risk electric shock.



Do not drop or subject to strong impact

Do not drop this product or subject it to strong impact.



Do not disassemble

Do not disassemble or modify this product and AC adapter.



Do not damage the power cord

Do not excessively bend the power cord or damage it. Do not place heavy objects on top of the power cord. Doing so may damage the power cord, causing fire or electric shock.



Use the included AC adapter

Use only the included AC adapter. Use the adapter with the voltage that it specifies.

CAUTION



Do not place the product in an unstable location

Doing so may cause the product to overturn, causing personal injury.



Do not sit or stand on the product, or place heavy objects on it

Doing so may damage the product. You should also avoid applying excessive force to the buttons, knobs, display, and input/output jacks. Doing so will cause malfunctions.



Do not use the product at a high volume for an extended time

Using speakers or headphones at high volume for an extended time will damage your hearing.



Grasp the power plug when connecting or disconnecting

When connecting or disconnecting the AC adapter from the product, you must grasp the plug rather than pulling the power cord.



Disconnect the power plug from the AC outlet during lightning storms or when unused for long periods of time

Failure to do so may cause electric shock, fire, or malfunction.



Disconnect all connections before moving the product

Failure to do so may cause damage to the power cord or cables, or may cause people to trip over the cables.



Handle the product with care

Take care that your hands or fingers are not injured by corners, edges or openings of the product.



Keep small parts out of reach of children

Keep small parts out of reach of children who might accidentally swallow them.



Supervise or give guidance when children use this product or children are present around this product

Always take care that children are not injured with this product.

Important Information

Power supply

- A small amount of current flows even when the power is turned off. If you will not be using this product for an extended period of time, you may desire to unplug the AC adapter from the AC outlet.

Regulatory compliance for radio emission devices

- You should keep turning the Bluetooth off when using the product in a country/region other than where it sold.
- The following actions may violate the law.
 - Disassembling or modifying this product.
 - Removing the certification label on the product.

Placement

- Do not use this product near other electrical products such as televisions, radios. This product may cause noise in televisions or radios.

Cleaning

- Use a soft dry cloth to clean the product. Do not use benzene, thinner, detergent, or chemically treated cloth, since these can cause deformation or discoloration.

Data

- Please be aware that the manufacturer bears no responsibility for any consequences that may arise from damage to or loss of data.
- In some cases, equipment malfunction or incorrect operation can cause the contents of the memory to be lost. Please make a backup of any important data that is in the memory.

Copyright

- Duplication or reuse of the music and sound data contained in or included with this product without permission from the copyright holder is forbidden (with the exception of copying for personal use as permitted by copyright law).
- Copyright for the content (sound data, phrase data, audio data, image data, computer programs, etc.) contained in or included with this product is the property of Ef-Note Inc. Copyright law forbids you to use the above content without permission of Ef-Note Inc. for any purpose other than personal use.
- The above content that is contained in or included with this product may not be resold, distributed, or published, neither in its existing form nor in any way that resembles it.

Others

- ASIO is a trademark and software of Steinberg Media Technologies GmbH.
- The Bluetooth® word mark and logos are registered trademarks owned by Bluetooth SIG, Inc..
- Company names or product names etc. appearing in this document are the registered trademarks or trademarks of their respective corporate owners.
- EFNOTE is a trademark or registered trademark of Ef-Note Inc.
- All illustrations and screens appearing in this document are for the purpose of explaining operation, and may differ from the actual product or specifications.

* Ef-Note Inc. cannot be held responsible for damage caused by improper use or modifications to the product, or loss of data.

For EU countries



Ef-Note Inc. hereby declares that the type of radio equipment EFNOTE 7 (EFD7-STDSET) complies with Directive 2014/53/EU. The full text of the EU Declaration of Conformity is available at : ef-note.com/compliance



This symbol on the product means that used electrical and electronic equipment should not be mixed with general household waste. The correct disposal will help prevent potential negative effects on human health and the environment. For proper treatment, recovery and recycling, please contact your city office, waste disposal servicer or the shop which you purchased the product.

For the USA

WARNING

This product contains a chemical known to the State of California to cause cancer, birth defects or other reproductive harm.

FCC INFORMATION

This equipment has been tested and found to comply with the limits for a Class B digital device, pursuant to part 15 of the FCC Rules. These limits are designed to provide reasonable protection against harmful interference in a residential installation. This equipment generates, uses and can radiate radio frequency energy and, if not installed and used in accordance with the instructions, may cause harmful interference to radio communications. However, there is no guarantee that interference will not occur in a particular installation. If this equipment does cause harmful interference to radio or television reception, which can be determined by turning the equipment off and on, the user is encouraged to try to correct the interference by one or more of the following measures:

- Reorient or relocate the receiving antenna.
- Increase the separation between the equipment and receiver.
- Connect the equipment into an outlet on a circuit different from that to which the receiver is connected.
- Consult the dealer or an experienced radio/TV technician for help.

This device complies with part 15 of the FCC Rules. Operation is subject to the following two conditions:

- (1) This device may not cause harmful interference, and
- (2) this device must accept any interference received, including interference that may cause undesired operation.

Assembling

■ Packing List

A	Sound Module	1x
B	20" Kick	1x
C	14" Snare with Side-Rim	1x
D	11" Tom	1x
E	15" Floor Tom	1x
F	14" Hi-Hat Cymbals	1x
G	16" Standard Cymbal	1x
H	20" Ride Cymbal	1x

K	Smartphone Tray	1x
L	Floor Tom Leg	3x
O	Module Mount Set	1x
P	Multi-A5 Cable	1x
Q	Multi-B Cable	1x
R	Trigger Cable	5x
S	AC Adapter	1x

T	Beater Patch	1x
U	Hex Key	1x
	Tuning Key	1x
	Cable Tie	10x
	Quickstart Guide	1x

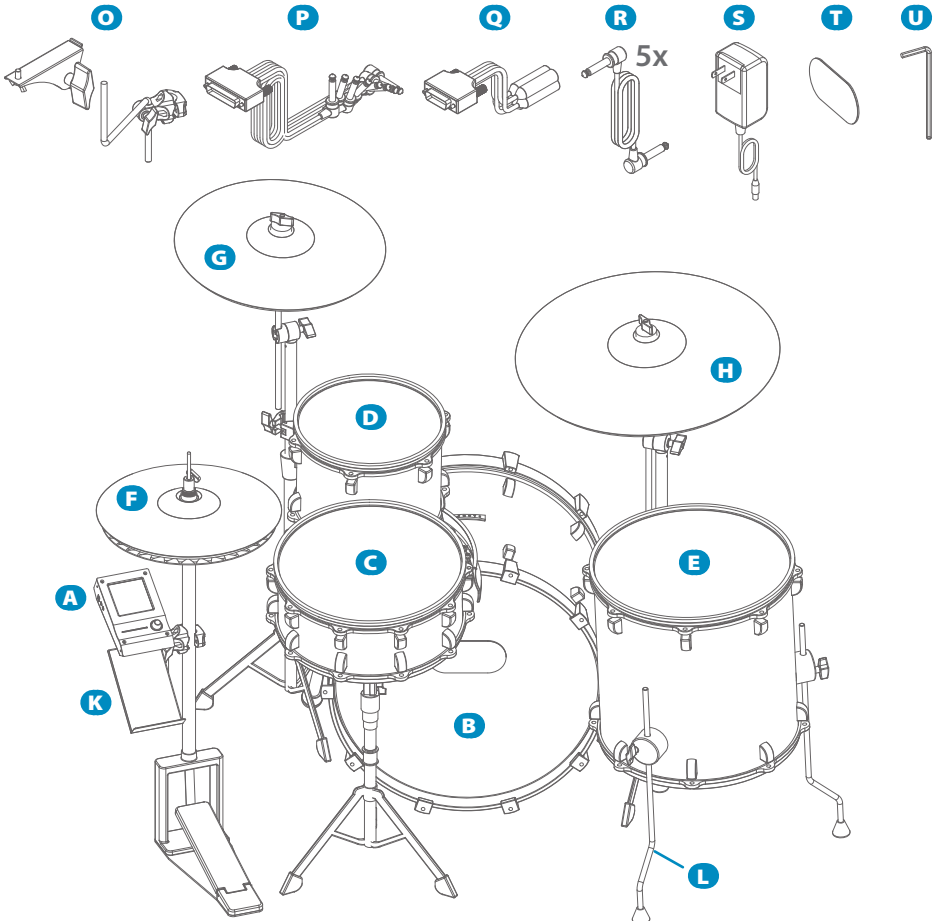

* Kick pedal, hi-hat stand, snare drum stand, tom mount, crash and ride cymbal stands are not included.

* Snare drum stand, tom mount, crash and ride cymbal stands are sold separately.

■ Assembly

CAUTION Please take your time with assembly and contact us with any questions (p. 19).

1

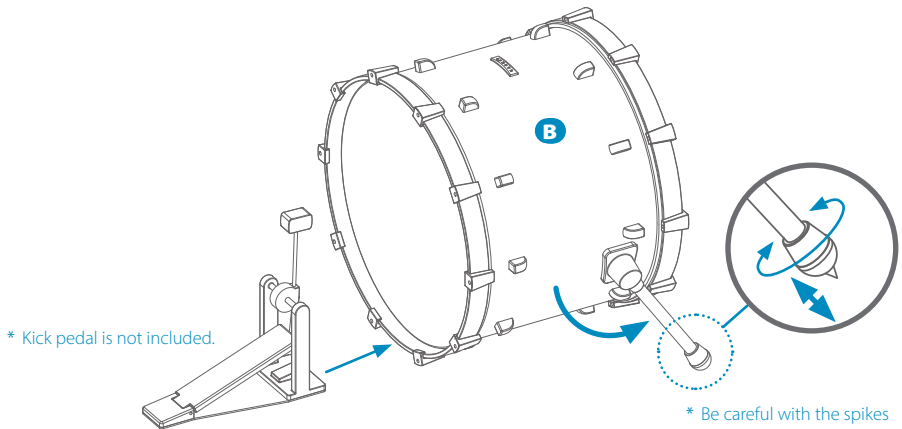

2

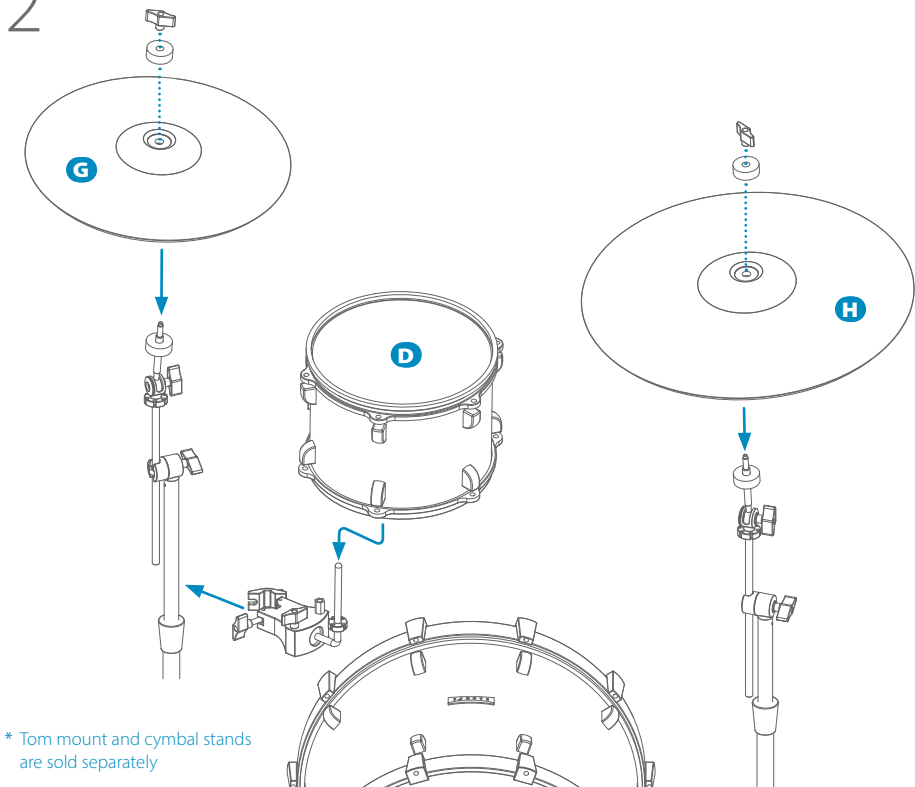

3

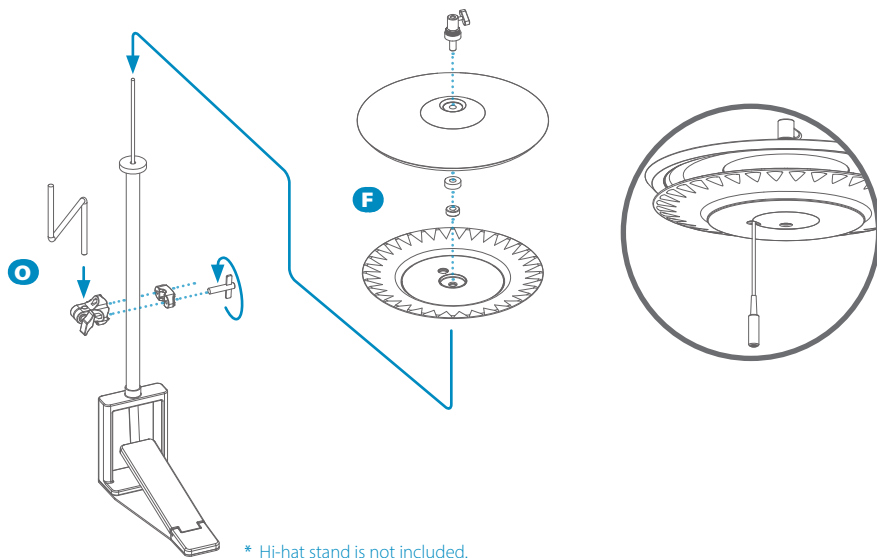

4

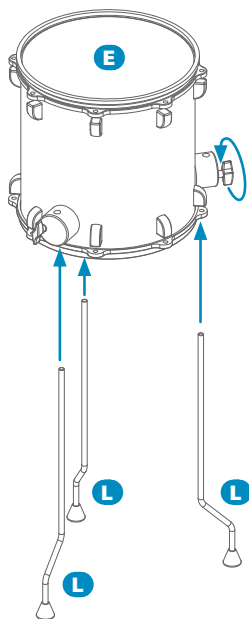

5

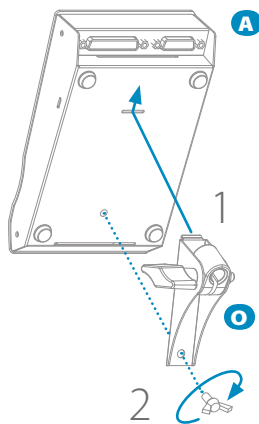

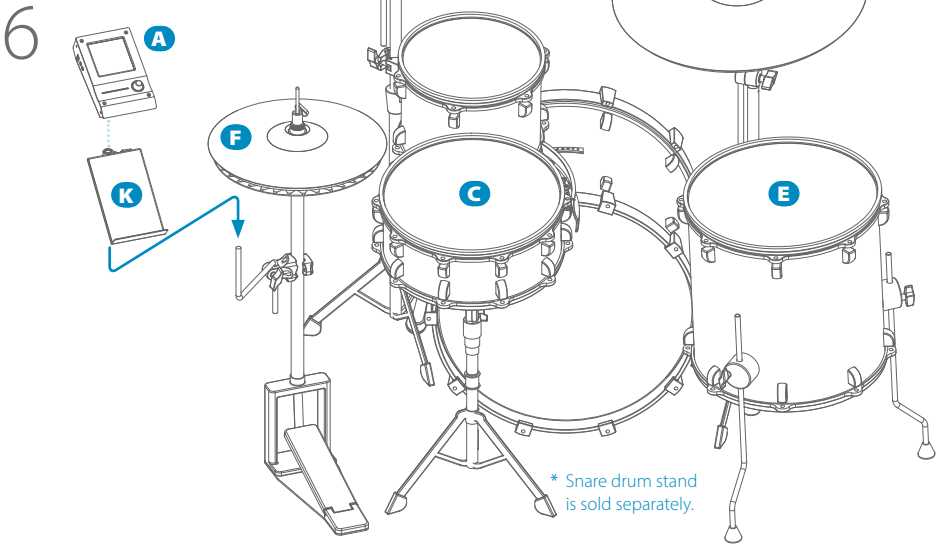

■ Adjusting the Side-Rim Position

The side-rim can be moved side to side, to adjust its position. Loosen the bolts shown in the figure with included hex key, and adjust the position, then tighten up the bolts again.

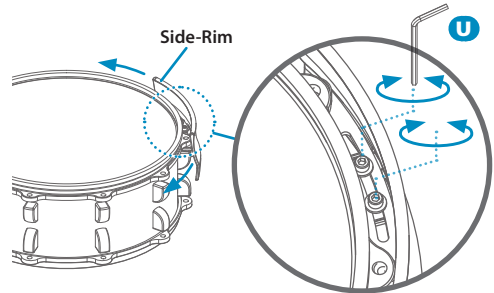

■ Attaching the Beater Patch

Attach the beater patch to where the kick pedal beaters touch on the head of the kick.

- * Playing without the beater patch may cause damage of the head.
- * The beater patch is a consumable item. Replace when it has worn.

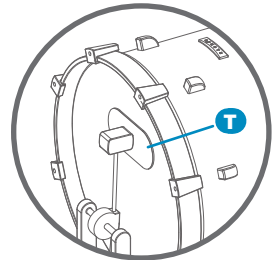

■ Tuning the Head Tension

Make sure the mesh drum heads are not too loose. Tighten up the tuning bolts evenly with the tuning key, if needed.

- * The mesh drum head is a consumable item. Replace when it has worn.

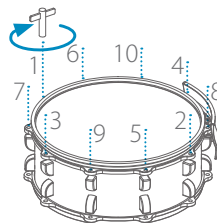

Connection

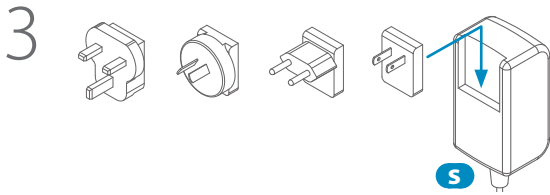
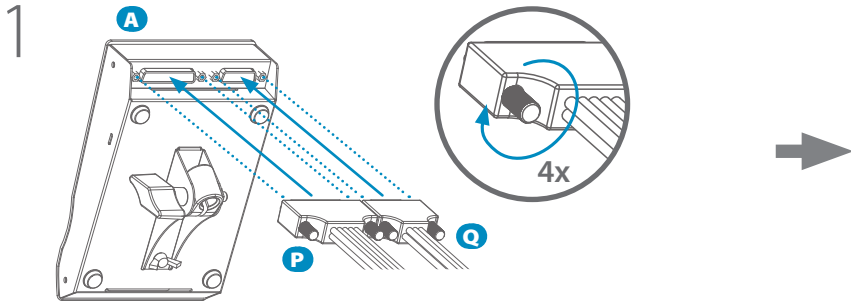

Firmly attach the included plug which is suitable for the outlet in your region.

* Use only the included AC adapter and plug.

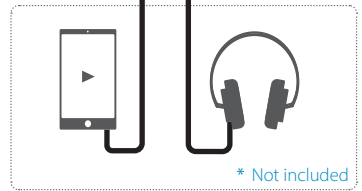
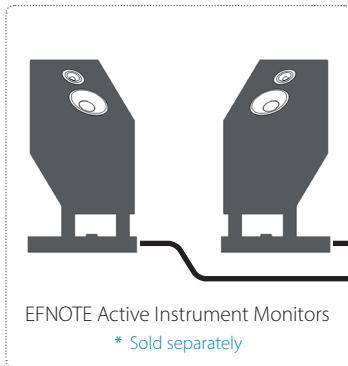
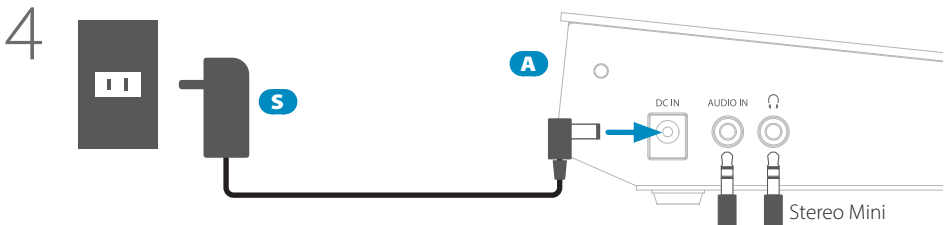

OUT 2/R
OUT 1/L
1/4" Phone

MIDI OUT

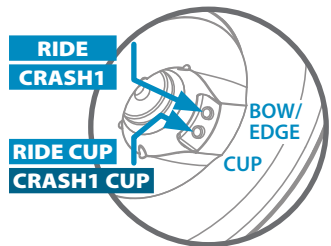
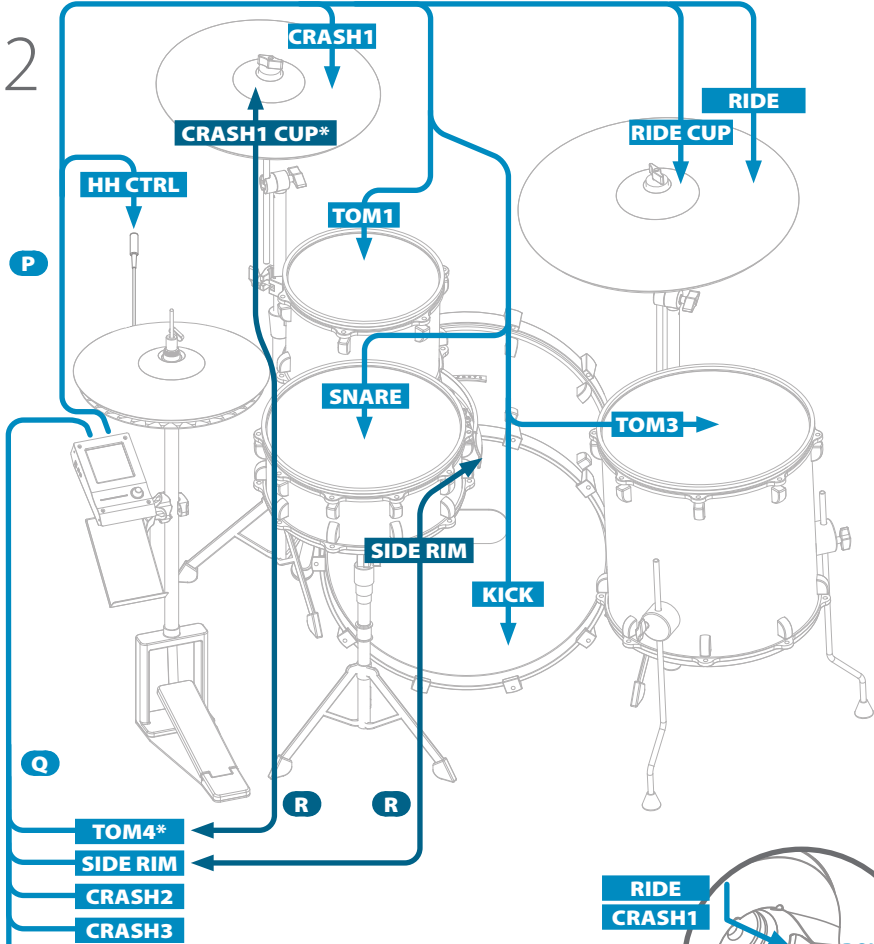

- * The EFNOTE 7 does not include Tom 2, Tom 4 and Crash 2, Crash 3 pads in the package.
- * You can use the TOM 4 cable for the Crash 1 Cup. You can use the CRASH 3 cable for the Crash 2 Cup. See the reference guide PDF for the detail.

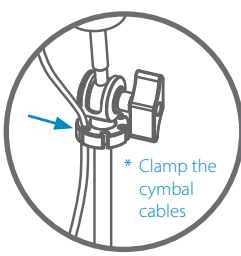
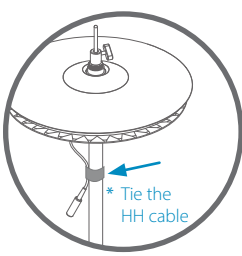

Basic Operation

■ Panel Description

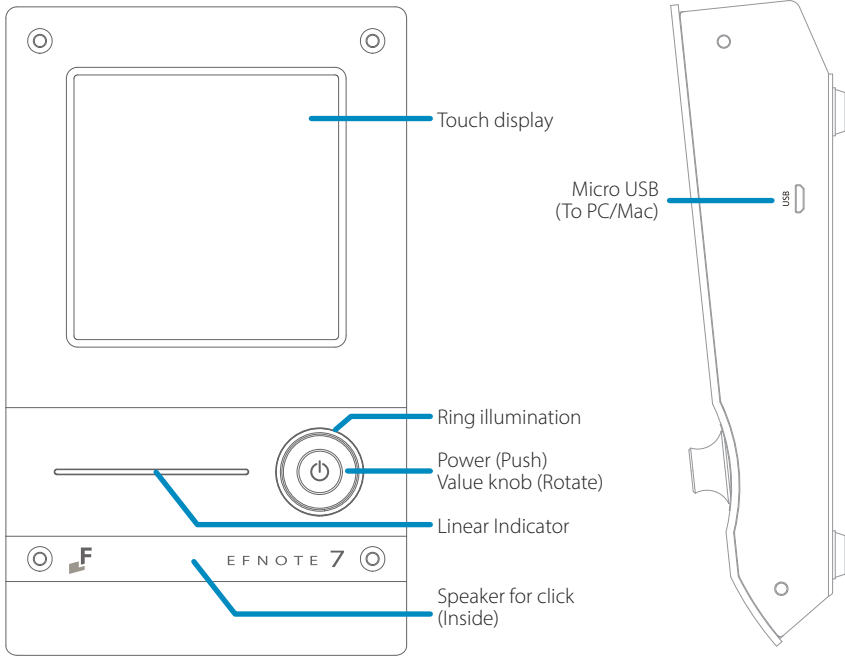

■ Power On/Off

Power On

1



2



Power Off

1



2

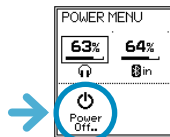

3

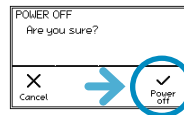

4



* Without this procedure may result in loss of changes.

* The power save function will turn power off automatically after specified period. It can be disabled (p. 17).

■ Home Screen

Switching drum kits

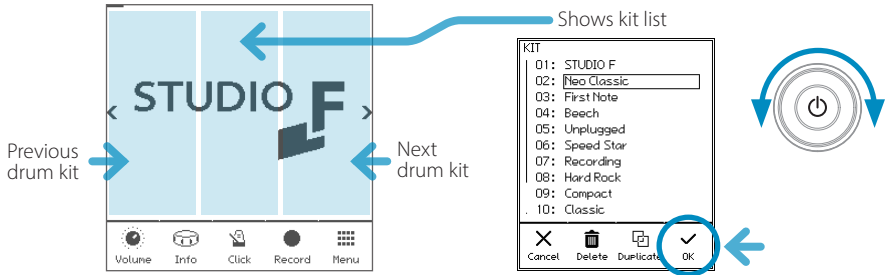

■ Volume

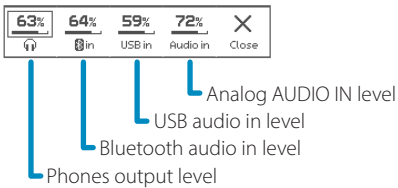

CAUTION Be sure not to listen to audio at a high volume. It can cause permanent hearing loss.

■ Inst Info

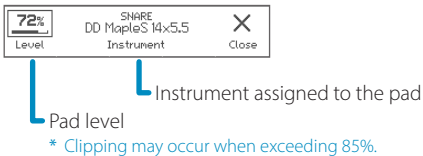

■ Click (Metronome)

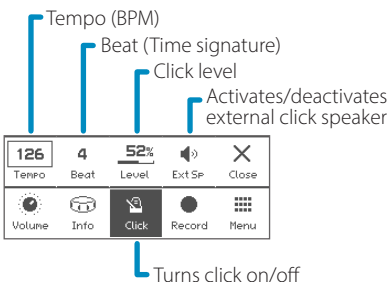

■ Recorder

Records your drum performances by MIDI.

* Any other audio sources are not recorded.

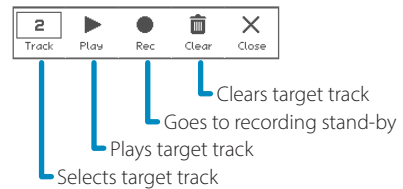

Rec Standby

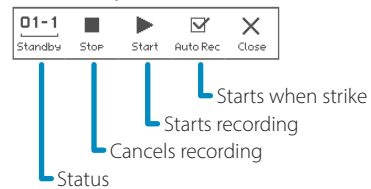

Recording

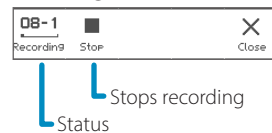

Playing



Menu



- Kit Edit: Changes instrument on each pad (p. 15)
Edits drum kit
- Levels: Shows the pad level faders (p. 15)
- Inst Library: Manages your user custom instruments
- Set List: Organizes drum kits for gigs



- Click Setup: Configures click setup
- Stroke Scope: Displays your strike points on timeline
- Accuracy Score: Estimates your strike accuracy
- Rhythm Box: Provides basic drum beats



- Volume: Shows the volume control
- Bluetooth: Connects Bluetooth device (p. 16)
- Trigger: Configures triggers (pads)
- Settings: Configures general settings
- Close: Closes menu

For the detailed information about screens can be accessed from the menu, please refer to the "Reference Guide" available on the website below.

ef-note.com/products/drums/EFNOTE7/efnote7.html#downloads



Power Menu

You can access the power menu anytime.

1



* Push the knob again to close the menu.

2

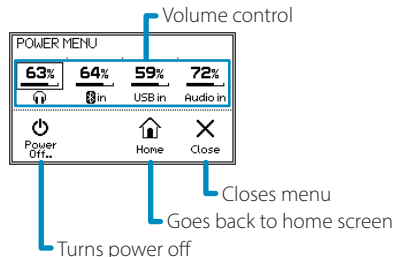

■ Changing the Instrument

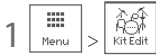

2 Hit the pad you want to change its instrument.

3

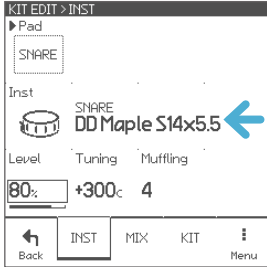

4

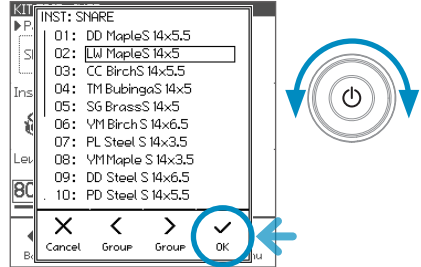

Changes are saved automatically.

■ Adjusting the Pad Levels



2 Choose a pad.

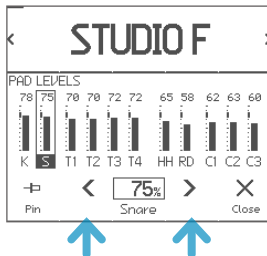

3 Adjust the level.

* Clipping may occur when exceeding 85%.



* You can also choose the pad by hitting it.

* If pinned, the selected pad cannot be changed by hit.

Changes are saved automatically.

■ Connecting Your Smart Device with Bluetooth

You can connect your smart device to the EFNOTE 7 to listen to audio with Bluetooth.

Connecting

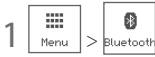

- 2 Make sure the status is "Ready to pair".
If the status is "OFF", tap it to turn on.

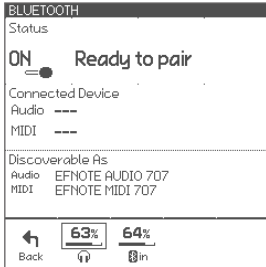

On your smart device

- 3 Turn Bluetooth on.
- 4 Find new device discoverable as "EFNOTE AUDIO xxx" (xxx is any value), and select it.
- 5 If pin code is required, enter "0000" (four zeros).
- 6 Tap [Pair].

- 7 Make sure the status changes to "Connected", and your device name is displayed.

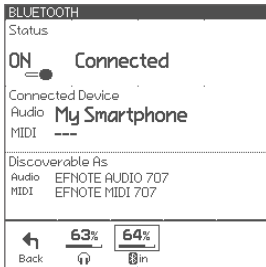

Controls Bluetooth input volume

- 8 Now, you can listen to the audio playing on your smart device.

* Make sure to increase the volume of your smart device.

CAUTION Be sure not to listen to audio at a high volume. It can cause permanent hearing loss.

Disconnecting

- 1 Tap [Disconnect] on your smart device.

Re-connecting

- 1 Tap [Connect] on your smart device.

■ Changing the Power Save Setting



2

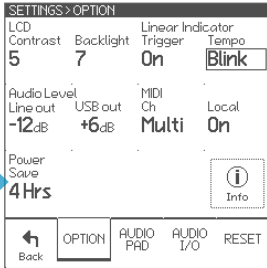

3



When "Off", the module will not turn off automatically.

■ Adjusting the Hi-Hat (Auto Calibration)



2

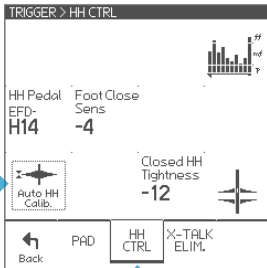

3

Drop the top hi-hat cymbal.

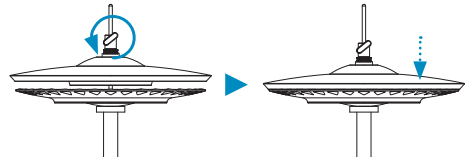

4

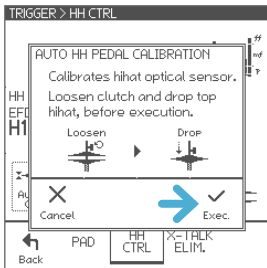

Adjusting the hi-hat manually

- When the hi-hat sound is not closed enough despite you press the pedal firmly, increase the "Closed HH Tightness" value.
- When the hi-hat sound is not open easily even if you slightly release the pedal, decrease the value.
- The default setting is "0".

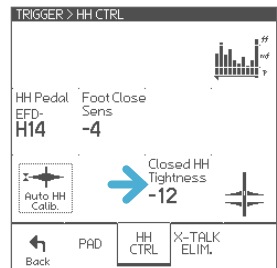

Specifications

Electronic Drum Kit: EFNOTE 7

Sound Module: EFD-7

Item	Specifications
Trigger Interface	<ul style="list-style-type: none"> • 3-Zone: Snare, Crash 1/2*, Ride • 2-Zone: Tom 1/2/3/4, HH, Crash 3 • 1-Zone: Kick <p>* Crash 1 and Crash 2 inputs support 3-zone triggering with using TOM 4/CRASH 3 cables. * Tom 2, Tom 4, Crash 2, and Crash 3 pads are not included.</p>
Audio / MIDI Interface	<ul style="list-style-type: none"> • Line (1/2) Output: 2x 1/4"TS Phone (+4dBu, Unbalanced) • Phones (3/4) Output: Stereo Mini-Phone (320 mW + 320 mW @32Ω) • Audio Input: Stereo Mini-Phone (+2dBu Max) • USB: Audio 8-ch Output / 2-ch Input (Mac/Windows ASIO, USB 2.0 Hi-Speed), MIDI In/Out • Bluetooth: Audio Input (A2DP), MIDI In/Out (Bluetooth Low Energy/GATT) <p>Transmission Frequency: 2402--2480 MHz, Maximum Transmit Power: 2.5 mW EIRP</p> <ul style="list-style-type: none"> • MIDI Out: 5-pin DIN
Recorder	<ul style="list-style-type: none"> • Resolution: 480 TPQN • Tracks: 15 • Capacity: Approx. 8,000 Events/Track
Power supply	DC 12V, 500 mA (Nominal) / 800 mA (Max)
Dimensions / Weight	172 (W) x 106 (D) x 47 (H) mm / 700 g * Excluding protrusions

Pads and accessories:

Item	Specifications
Kick (EFD-K2015)	<ul style="list-style-type: none"> • Size: 20 x 15" • Zone: Head • Sensor: Multi • Connector: Head (1/4"TRS Phone)
Snare (EFD-S1455)	<ul style="list-style-type: none"> • Size: 14 x 5.5" • Zone: Head / Rim / Side-Rim • Sensor: Multi • Connector: Head/Rim, Side-Rim (2x 1/4"TRS Phone)
Tom (EFD-T1180) Floor Tom (EFD-T1515)	<ul style="list-style-type: none"> • Size: 11 x 8" (Tom), 15 x 15" (Floor Tom) • Zone: Head / Rim • Sensor: Multi • Connector: Head/Rim (1/4"TRS Phone)
Hi-Hat (EFD-H14)	<ul style="list-style-type: none"> • Size: 14" (Top/Bottom) • Zone: Bow / Edge / Cup • Pad Sensor: Multi (360° flat sensing + choke) • Motion Sensor: Optical • Connector: 6-pin <p>* EFNOTE 7 sound module does not support hi-hat cup zone.</p>
Crash (EFD-C16) Ride (EFD-C20)	<ul style="list-style-type: none"> • Size: 16" (Crash), 20" (Ride) • Zone: Bow / Edge / Cup • Sensor: Multi (360° flat sensing + choke) • Connector: Bow/Edge, Cup (2x 1/4"TRS Phone)
Accessories	<p>Brake-Out Cable (EFD-MULTI-A5), Brake-Out Cable (EFD-MULTI-B), 5x Trigger Cable 3.0 m (EFD-TRS-LL3), Module Mount, Beater Patch, Smartphone Tray, AC Adapter, Cable Ties, Hex Key, Tuning Key, Quickstart Guide</p> <p>* Kick pedal, hi-hat stand, snare stand, tom mount, cymbal stand, drum throne are not included.</p>

* Specification and design are subject to change without prior notice.

■ Optional components and consumable parts

Option	Item	Description
Adding an upper tom	EFD-T1070-WS	Rack Tom 10" (White Sparkle) * Using the TOM 1 cable for the new 10", and TOM 2 cable for the 11".
	EFD-TM5	Tom Mount
Adding an upper floor tom	EFD-T1313-WS	Floor Tom 13" (White Sparkle) * Using the TOM 4 cable.
Adding a splash cymbal	EFD-C08	• Splash Cymbal 8" * Using the CRASH 3 cable.
	EFD-SCM5	Splash Cymbal Mount
Adding a 2nd crash cymbal	EFD-C18	Standard Cymbal 18" * Using the CRASH 2 cable.
	EFD-CS5	Cymbal Stand
Adding a 4th crash cymbal	EFD-C16	Standard Cymbal 16" * Using the TOM 2 or TOM 4 cable. * In this case, you need to change instrument assigns for the Tom 2/4 pad.
	EFD-CS5	Cymbal Stand
Replacing the drum head	EFD-MDH11	Mesh Drum Head 11"
	EFD-MDH14	Mesh Drum Head 14"
	EFD-MDH15	Mesh Drum Head 15"
	EFD-MDH20	Mesh Drum Head 20"
Replacing the beater patch	EFD-KBP2	Kick Beater Patch

* When any optional pad is added, configure the Assign and Pad model in the Trigger screen.
See the Reference Guide for the detail.

* Note that multiple options which use same cable cannot be applied.

Support

Please contact us with questions and comments, we love to hear from you.

Artesia Pro Inc.

✉ info@artesia-pro.com

🌐 artesia-pro.com



E F N O T E

ef-note.com