



# AC 41

Active Antenna Combiner

Quick Guide  
Kurzanleitung  
Guide rapide  
Guida rapida  
Guía de inicio rápido  
Guia rápido  
Beknopte handleiding  
Krótka instrukcja obsługi  
Snabbguide

Kort vejledning  
Pikaohje  
Γρήγορος οδηγός  
Kısa Kılavuz  
Краткая инструкция  
快速指南  
快速使用指南  
クイックガイド  
퀵 가이드

**SENNHEISER**

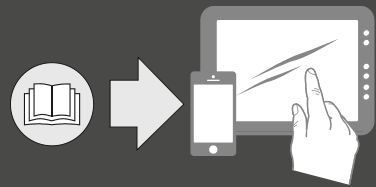

**Sennheiser Documentation App**



or online at  
[www.sennheiser.com/download](http://www.sennheiser.com/download)

AC 41\_

Sennheiser electronic GmbH & Co. KG

Am Labor 1, 30900 Wedemark, Germany  
[www.sennheiser.com](http://www.sennheiser.com)

Publ. 03/18, 578662/A02

## AC 41

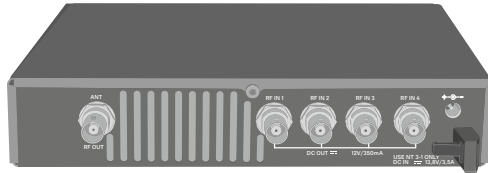

## Operating elements

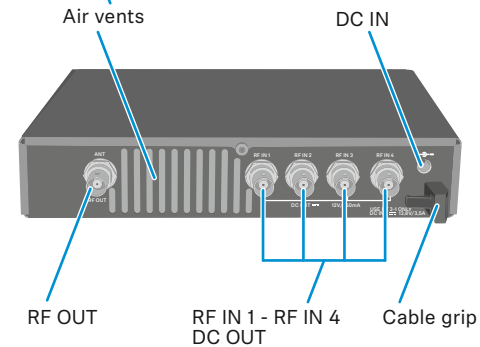
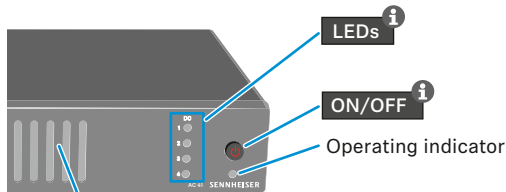

## Setup

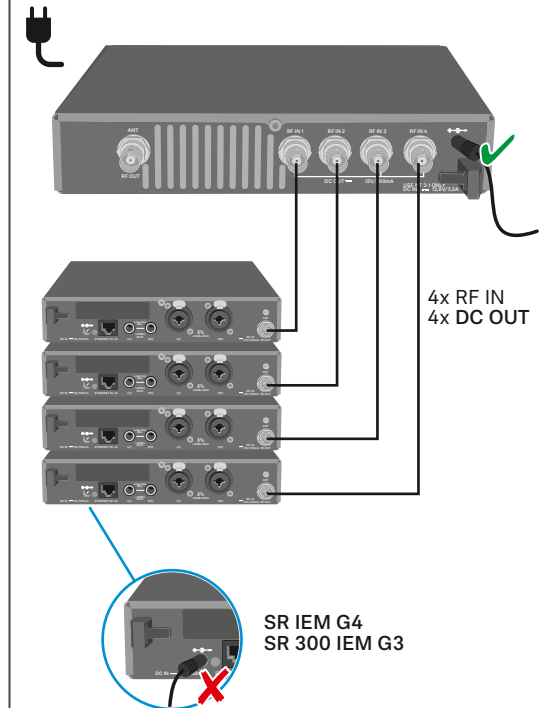
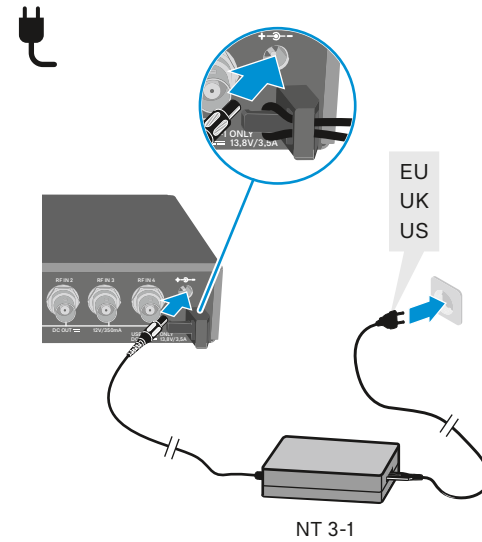
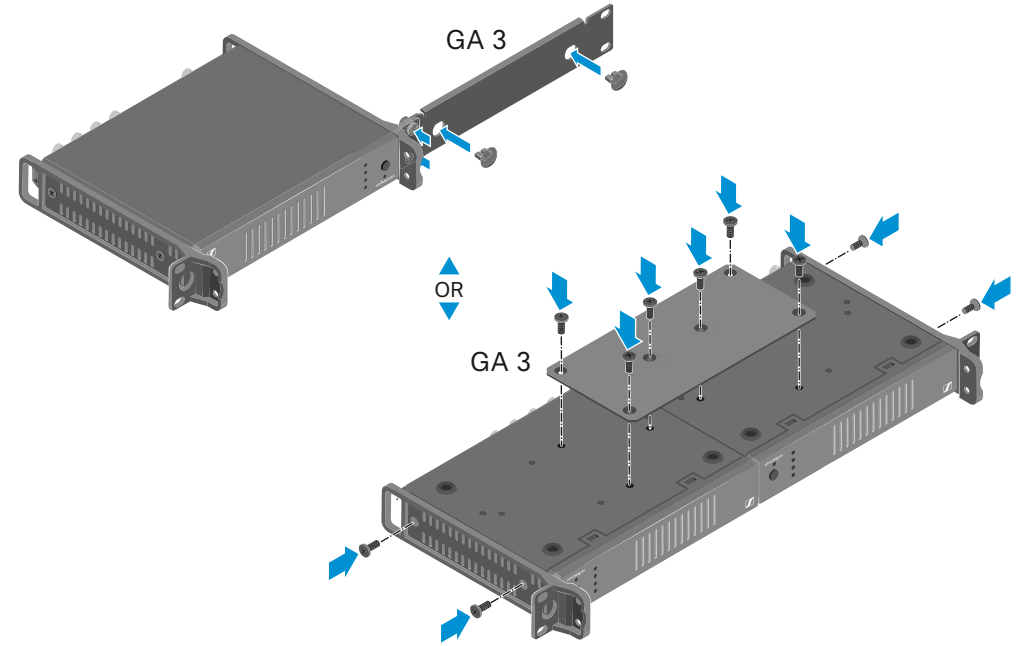

### ON/OFF

#### ON/Standby

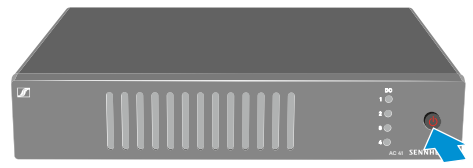

	AC 41	transmitter	LEDs
short	on	RF signal	on <b>LEDs</b> <sup>i</sup>
long	standby	off	off

#### OFF

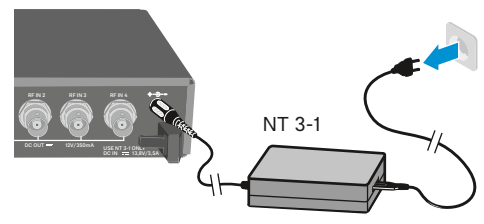

### LEDs

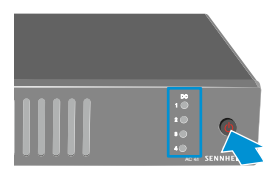

AC 41 = on

LEDs	DC to transmitters
on	✓
off	✗ →

### Connecting devices

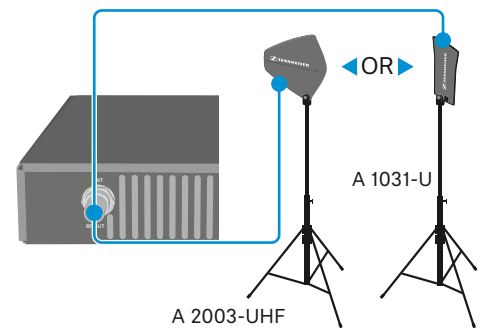

Remote antennas and maximum cable lengths → Instruction Manual

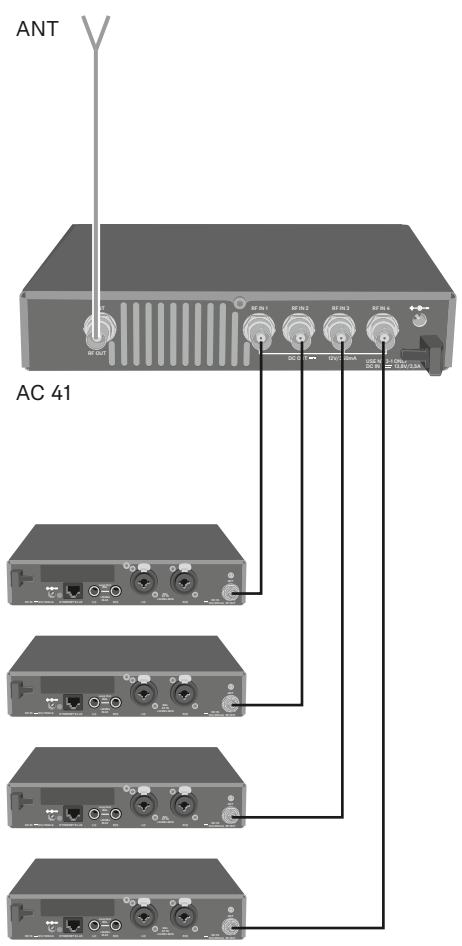

SR IEM G4  
SR 300 IEM G3

### Block diagram

