

# User Guide

## Clear-Com HME DX410 Dual-Channel Wireless Intercom



Part Number: 399G162 Rev C  
Date: 5/22/17

Copyright © 2017 Clear-Com, LLC, an HM Electronics, Inc. company. All rights reserved.  
Clear-Com, the Clear-Com logo and Clear-Com Concert are trademarks or registered trademarks of  
HM Electronics, Inc.

The product described in this document is distributed under licenses restricting its use, copying,  
distribution, and decompilation/reverse engineering. No part of this document may be reproduced in  
any form by any means without prior written authorization of Clear-Com, an HME Company.  
Clear-Com Offices are located in California, USA; Cambridge, UK; Montreal, Canada; and Beijing,  
China. Addresses and contact information can be found on Clear-Com's corporate website at [www.  
clearcom.com](http://www.clearcom.com).

## **Clear-Com Contacts**

### **Americas and Asia-Pacific Headquarters**

#### **California, United States**

Tel: +1.510.337.6600

Email: [CustomerServicesUS@clearcom.com](mailto:CustomerServicesUS@clearcom.com)

### **Europe, Middle East, and Africa Headquarters**

#### **Cambridge, United Kingdom**

Tel: +44 1223 815000

Email: [SalesSupportEMEA@clearcom.com](mailto:SalesSupportEMEA@clearcom.com)

### **Canada Office**

#### **Quebec , Canada**

Tel: +1 (450) 653-9669

### **China Office**

#### **Beijing Representative Office**

#### **Beijing, P.R.China**

Tel: (008610)-8528-8748



## FCC NOTICE

This device complies with Part 15 of the FCC rules. Operation is subject to the following two conditions: (1) This device may not cause harmful interference, and (2) This device must accept any interference received, including interference that may cause undesired operation.

**NOTE:** This equipment has been tested and found to comply with the limits for a Class A digital device, pursuant to Part 15 of the FCC rules. These limits are designed to provide reasonable protection against harmful interference when the equipment is operated in a commercial environment. This equipment generates, uses and can radiate radio frequency energy and, if not installed and used in accordance with the instruction manual, may cause harmful interference to radio communication. Operation of this equipment in a residential area is likely to cause harmful interference, in which case the user will be required to correct the interference at his own expense.

Changes or modifications not expressly approved by Clear-Com, LLC, an HM Electronics, Inc. company could void the user's authority to operate this equipment.

## MANDATORY SAFETY INSTRUCTIONS FOR INSTALLERS AND USERS

Use only manufacturer or dealer supplied antennas, power supplies, batteries and battery chargers. The Federal Communications Commission has adopted a safety standard for human exposure to RF (Radio frequency) energy, which is below the OSHA (Occupational Safety and Health Act) limits.

Base Station Antenna minimum safe distance: 7.9 inches (20 cm) at 100% duty cycle.

Base Station Antenna gain: This device has been designed to operate with an antenna having a maximum gain of up to 7dBi.

Antenna mounting: The antenna(s) used for the base transmitter must be installed to provide a separation distance of at least 7.9 inches (20 cm) from all persons and must not be co-located or operating in conjunction with any other antenna or transmitter.

Antenna substitution: Do not substitute any antenna for the one supplied by the manufacturer. You may be exposing person or persons to excess radio frequency radiation. You may contact your dealer or the manufacturer for further instructions.

**WARNING:** Maintain a separation distance from the base station transmit antenna to a person(s) of at least 7.9 inches (20 cm) at 100% duty cycle.

**WARNING:** Excessive sound pressure level from earphones or headphones can cause hearing loss. You, as the qualified end-user of this radio device must control the exposure conditions of bystanders to ensure the minimum separation distance (above) is maintained between the antenna and nearby persons for satisfying exposure compliance. The operation of this transmitter must satisfy the requirements of Occupational /Controlled Exposure Environment, for work-related use. Transmit only when person(s) are at least the minimum distance from the properly installed, externally mounted antenna.

## Canada IC Notice to Users English/French in accordance with RSS GEN

This device complies with Industry Canada license-exempt RSS standard(s). Operation is subject to the following two conditions: (1) this device may not cause interference, and (2) this device must accept any interference, including interference that may cause undesired operation of the device.

Cet appareil est conforme avec Industrie Canada RSS standard exempts de licence (s). Son utilisation est soumise à Les deux conditions suivantes: (1) cet appareil ne peut pas provoquer d'interférences et (2) cet appareil doit accepter Toute interférence, y compris les interférences qui peuvent causer un mauvais fonctionnement du dispositif.



Hereby, Clear-Com, LLC, an HM Electronics, Inc, company, declares that the DX410 is in compliance with the essential requirements and other relevant provisions of the RED (Radio Equipment Directive). In AFH mode, complies with European Telecommunications Standards Institute (ETSI) harmonized European standard EN 300 328.



This product operates in the 2400 to 2483.5 MHz frequency range. The use of this frequency range is not yet harmonized between all countries. Some countries may restrict the use of a portion of this band or impose other restriction relating to power level or use. You should contact your Spectrum authority to determine possible restrictions.

### **Korea KCC EMC Class A Warning**

A급기기(업무용방송통신기자재)

이 기기는 업무용 환경에서 사용할 목적으로 적합성 평가를 받은 기기로서 가정용 환경에서 사용하는 경우 전파 간섭의 우려가 있습니다.

English: Class A (Commercial broadcasting and communication equipment) Sellers and user should note that this equipment is an electromagnetic device for business (Class A) and intended for operation in non-residential locations.

### **Korea KCC 2.4Ghz device warning**

해당 무선설비는 전파혼신 가능성이 있으므로 인명안전과 관련된 서비스는 할 수 없음

English: This device cannot provide services related to human life safety.

## **WASTE ELECTRICAL AND ELECTRONIC EQUIPMENT (WEEE)**

The European Union (EU) WEEE Directive (2012/19/EU) places an obligation on producers (manufacturers, distributors and/or retailers) to take-back electronic products at the end of their useful life. The WEEE Directive covers most Clear-Com products being sold into the EU as of August 13, 2005. Manufacturers, distributors and retailers are obliged to finance the costs of recovery from municipal collection points, reuse, and recycling of specified percentages per the WEEE requirements.

### **Instructions for Disposal of WEEE by Users in the European Union**

The symbol shown below is on the product or on its packaging which indicates that this product was put on the market after August 13, 2005 and must not be disposed of with other waste. Instead, it is the user's responsibility to dispose of the user's waste equipment by handing it over to a designated collection point for the recycling of WEEE. The separate collection and recycling of waste equipment at the time of disposal will help to conserve natural resources and ensure that it is recycled in a manner that protects human health and the environment. For more information about where you can drop off your waste equipment for recycling, please contact your local authority, your household waste disposal service or the seller from whom you purchased the product.



Clear-Com, LLC, an HM Electronics, Inc. company, is not responsible for equipment malfunctions due to erroneous translation of its publications from their original English version. Illustrations in this publication are approximate representations of the actual equipment, and may not be exactly as the equipment appears.

# TABLE OF CONTENTS

<b>System Overview</b> .....	<b>6</b>
System Components .....	6
Base Station Front Panel .....	7
Base Station Rear Panel .....	8
Belt Pack – BP410 .....	8
All-In-One Headset – WH410 .....	9
<b>System Setup</b> .....	<b>10</b>
Battery Charging .....	10
Connect AC Power Supply .....	10
Charging the Batteries .....	11
Basic Base Station Setup .....	12
COMMUNICATOR® Setup and Registration .....	13
Interfacing with 2-Wire or 4-Wire Intercoms .....	17
Interfacing with Auxiliary Audio Equipment .....	18
ISO Relay .....	19
<b>System Operation</b> .....	<b>20</b>
Base Station Operation .....	20
<b>COMMUNICATOR® Operation</b> .....	<b>21</b>
<b>EU BASE STATION Adaptive Frequency Hopping</b> .....	<b>23</b>
<b>Troubleshooting</b> .....	<b>26</b>
<b>Technical Data</b> .....	<b>27</b>
BS410 Base Station Specifications .....	27
BP410 Belt Pack Specifications .....	28
WH410 All-In-One Headset Specifications .....	29
<b>Appendix A: COMMUNICATOR® Indicator Light Functions</b> .....	<b>30</b>
BP410 Belt Pack Indicator Lights .....	30
WH410 All-In-One Headset Indicator Lights .....	30
<b>Appendix B: Multiple Base Station Daisy-Chaining</b> .....	<b>31</b>
<b>Appendix C: Jumper Settings</b> .....	<b>32</b>
ISO Broadcast Restrict .....	32
2-Wire Channel Termination .....	32
<b>Appendix D: Interference Avoidance Through Spectrum Friendly</b> .....	<b>33</b>
Spectrum Friendly .....	34
Avoiding Wi-Fi Interference .....	34
<b>DX SERIES LED AID</b> .....	<b>35</b>
Syncing Primary to Secondary Bases Feature .....	35
Spectrum Friendly Feature .....	36
<b>Appendix E: Audio Routing Diagram</b> .....	<b>37</b>
<b>General Battery Safety Instructions for Battery Model BAT41, BAT50, BAT60</b> .....	<b>38</b>
French .....	39
Spanish .....	40
Korean .....	41

# SYSTEM OVERVIEW

The Clear-Com® HME DX410 is a 2-channel Digital Wireless Intercom System that supports up to 15 COMMUNICATOR®s per base station, either Belt Packs or All-In-One Headsets, or a combination of the two.

Using the DX410 in the 2-channel mode, any three of the 15 Communicators can operate in full duplex mode. In the single-channel mode, any four Communicators can operate in full duplex mode. This number can be increased by adding up to three additional base stations. The DX410 supports both Clear-Com and RTS cabled 2-wire intercom systems, and also has 4-wire and auxiliary audio connections.

## System Components

### BS410 Base Station



Antennas

110/240 Switching Power Supply



AC50 Batteries

WH410 All-In-One Headset



AC50 Battery Charger and Power Supply Adapter

BP410 Belt Pack



# Base Station Front Panel

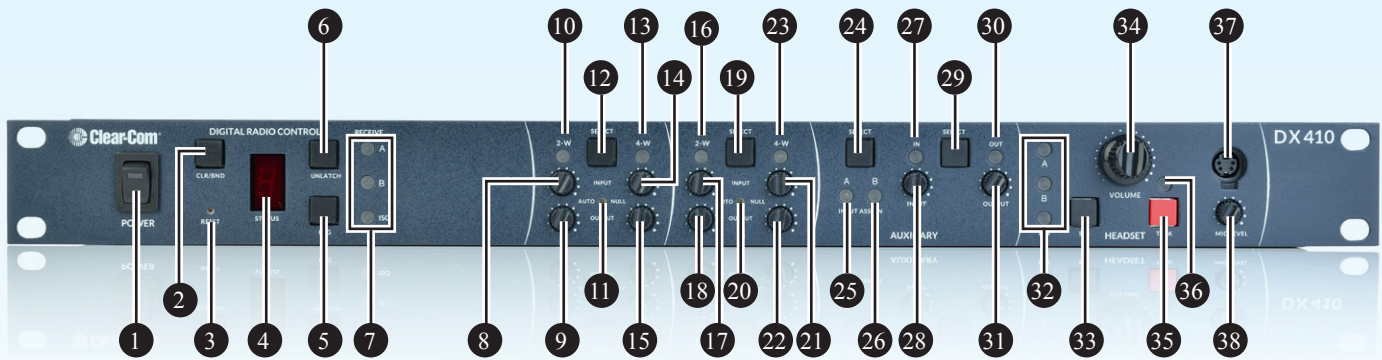

## Digital Radio Controls

1. POWER switch
2. CLR/BND button
3. RESET button (recessed)
4. STATUS display
5. REG (registration) button
6. UNLATCH button
7. RECEIVE indicator lights

## A Controls

8. (A) 2-W output level adjust
9. (A) 2-W input level adjust
10. (A) 2-W indicator light
11. (A) AUTO NULL button (recessed)
12. (A) 2-W/4-W SELECT button
13. (A) 4-W indicator light
14. (A) 4-W input level adjust
15. (A) 4-W output level adjust

## B Controls

16. (B) 2-W indicator light
17. (B) 2-W input level adjust
18. (B) 2-W output level adjust
19. (B) 2-W/4-W SELECT button

20. (B) AUTO NULL button (recessed)
21. (B) 4-W input level adjust
22. (B) 4-W output level adjust
23. (B) 4-W indicator light

## Auxiliary Controls

24. AUX INPUT SELECT button
25. AUX A INPUT ASSIGN indicator
26. AUX B INPUT ASSIGN indicator
27. AUX IN indicator light
28. AUX INPUT level adjust
29. AUX OUTPUT SELECT button
30. AUX OUT indicator light
31. AUX OUTPUT level adjust

## Headset Controls

32. HEADSET A, B & ISO indicator lights
33. HEADSET A, B & ISO SELECT button
34. HEADSET VOLUME knob
35. HEADSET TALK On/Off button
36. HEADSET TALK indicator light
37. HEADSET MIC LEVEL adjust
38. HEADSET cable connector

## Base Station Rear Panel

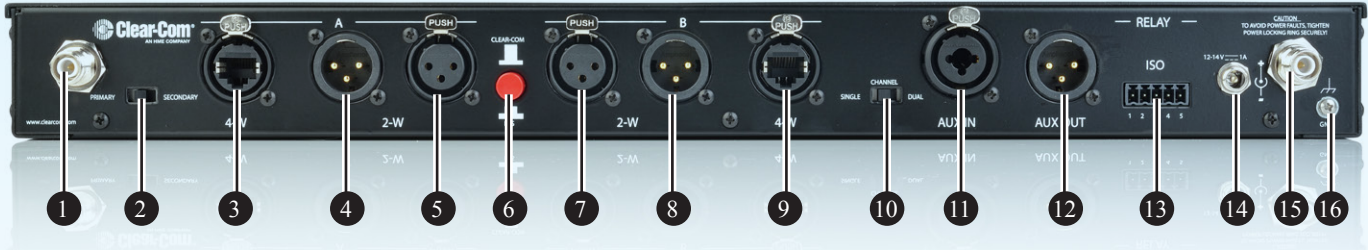

- |  |   |
|--|---|
| <ol style="list-style-type: none"> <li>1. ANT (R-TNC)</li> <li>2. PRIMARY/SECONDARY Select Switch</li> <li>3. (A) 4-W RJ-45 Connector</li> <li>4. (A) 2-W XLR-3M Connector</li> <li>5. (A) 2-W XLR-3F Connector</li> <li>6. CLEAR-COM/RTS Select Switch</li> <li>7. (B) 2-W XLR-3F Connector</li> <li>8. (B) 2-W XLR-3M Connector</li> </ol> | <ol style="list-style-type: none"> <li>9. (B) 4-W RJ-45 Connector</li> <li>10. SINGLE/DUAL Channel Select Switch</li> <li>11. AUX IN Connector</li> <li>12. AUX OUT Connector</li> <li>13. Relay Connector</li> <li>14. DC Power Connector</li> <li>15. ANT (R-TNC)</li> <li>16. Chassis Grounding Screw</li> </ol> |
|--|---|

## Belt Pack – BP410

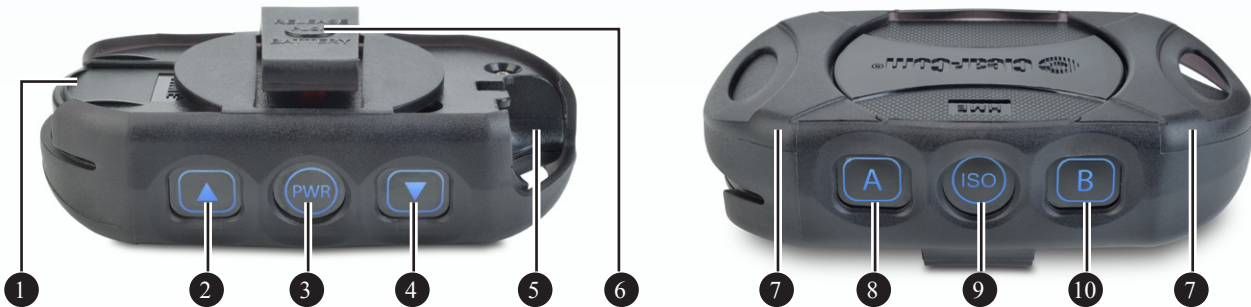

- |   |  |
|---|--|
| <ol style="list-style-type: none"> <li>1. Battery</li> <li>2. Volume-up button</li> <li>3. PWR (Power) button</li> <li>4. Volume-down button</li> <li>5. Headset cable connector</li> </ol> | <ol style="list-style-type: none"> <li>6. Battery-release latch</li> <li>7. Power/mode lights</li> <li>8. Channel A (Intercom 1) button</li> <li>9. ISO (Isolate) button</li> <li>10. Channel B (Intercom 2) button</li> </ol> |
|---|--|



## All-In-One Headset – WH410



1. Channel A (Intercom 1) button
2. ISO (Isolate) button
3. Volume-up button
4. Volume-down button
5. Channel B (Intercom 2) button

6. Power/mode light
7. Microphone
8. Power button
9. Battery
10. Battery-release latch

# SYSTEM SETUP

Displayed below is an example of a typical Clear-Com set up and configuration with the DX410.

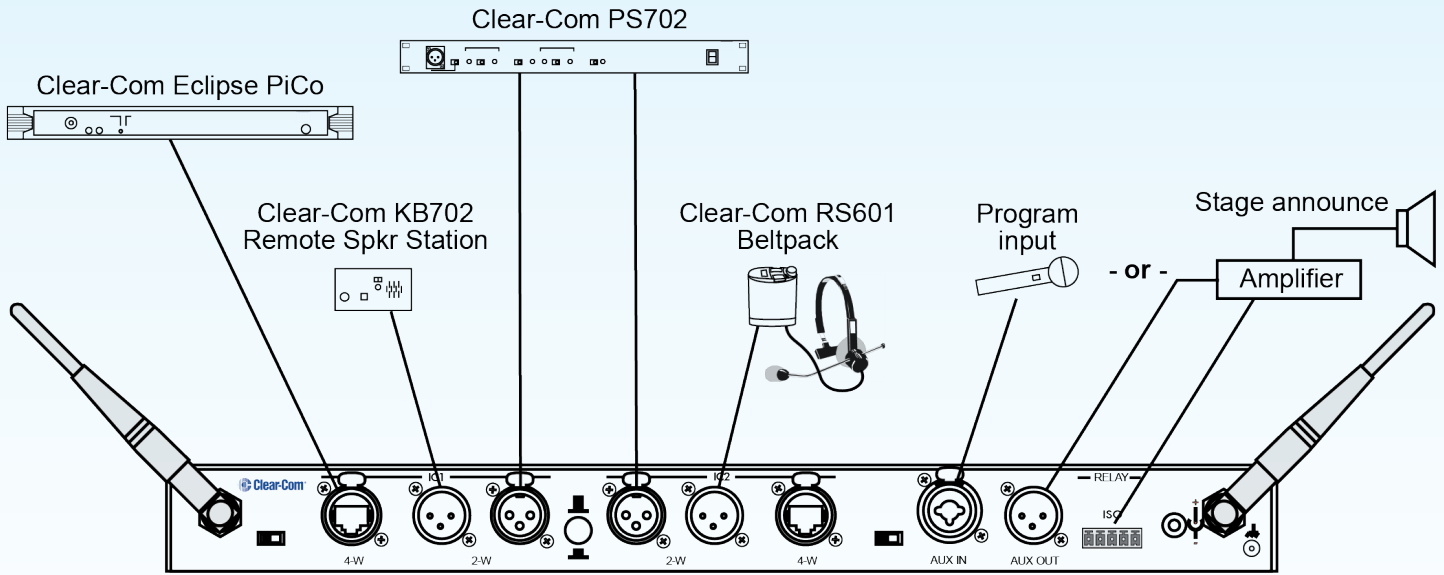

## Battery Charging

Before installing the system, connect the AC power supply to the battery charger and plug it into an electrical outlet. Charge all the batteries while the other equipment is being installed. Charging time is about 2.5 hours.



## Connect AC Power Supply

To connect the AC power supply to the battery charger:

1. Connect the AC power supply cable connector to the power connection on the battery charger.
2. Connect the AC power cord to an electrical outlet.

The red lights on the charger will briefly display, and then the yellow lights will appear and remain on.



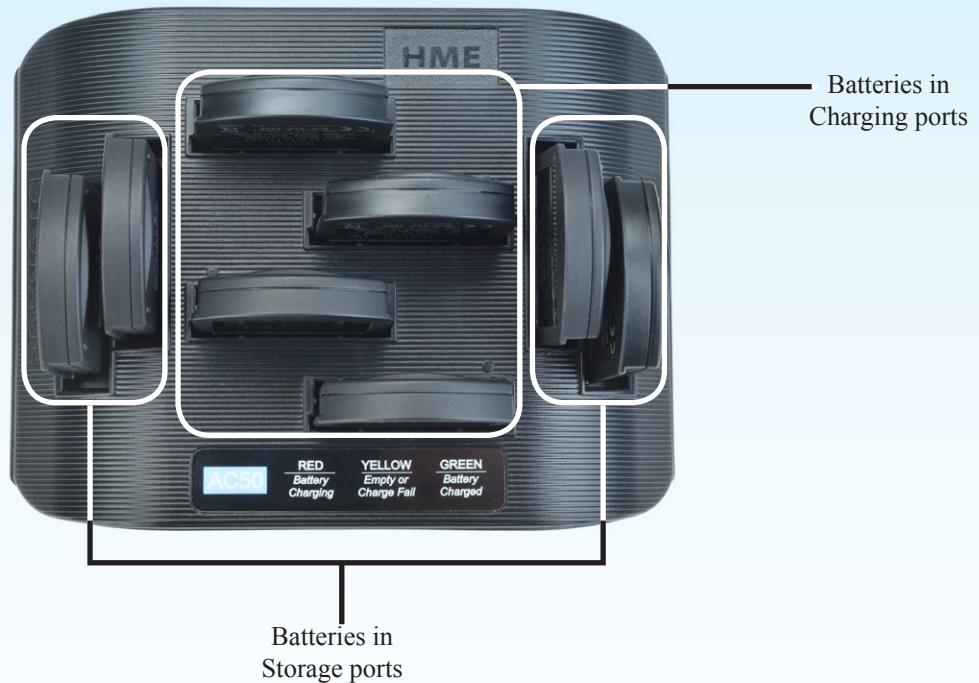

## Charging the Batteries

Up to four batteries can be charged in the battery charger at one time. The battery status lights next to each charging port indicate the battery status. Up to four fully charged batteries can be stored in the battery Storage ports. Insert a battery in each of four Charging ports until it clicks in place.

- A yellow light next to a Charging port indicates that the port is EMPTY.
- A red light next indicates that the battery port is CHARGING.
- A green light indicates that the battery is READY.
- A steady yellow light indicates that the CHARGE FAILED. If a charge fails, refer to the instructions on the side of battery charger.
- A flashing yellow light next indicates CHARGE PENDING, which means the inserted battery is too hot. Adjust the room temperature or move the charger to a cooler area.
- Store fully charged batteries in storage ports.

**NOTE:** Batteries should not be left in charge ports after being fully charged. A battery left in a charging port for more than three weeks may display the yellow indicator light, but it does not indicate a faulty battery.

## Basic Base Station Setup

This section describes setup and equipment connections for an individual base station.

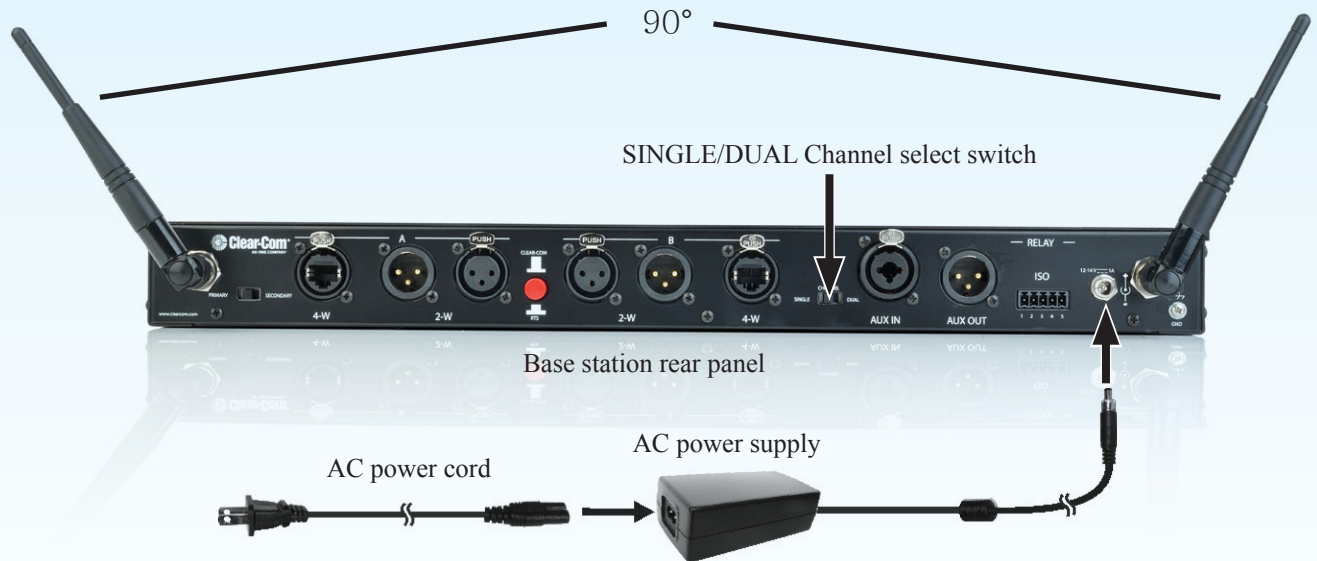

1. Connect the two enclosed antennas to the antenna connectors on the rear panel of the base station, and turn the sleeves clockwise on the antenna connectors to tighten them securely in place. Position the antennas at 90° angles from each other.
2. Plug the connector at the end of the AC power supply cord into the **+12-14VDC** power connector on the rear panel of the base station (as shown above). Turn the locking nut on the cable connector clockwise to secure it to the base station. Plug the female connector at one end of the AC power cord into the power supply. Plug the other end of the AC power cord into an electrical outlet.
3. Set the SINGLE/DUAL Channel select switch for the base station to operate in **Single** or **Dual** channel mode.
  - **In Single Channel mode**, all wireless users will be able to hear each other. Up to four users can talk simultaneously.
  - **In dual channel mode**, there are two separate audio channels enabling two groups of users to independently communicate with each other. Up to three users can talk simultaneously.

**NOTE:** Any time the mode is changed, the unit must be reset using the **RESET button** or by power cycling for the change to take effect.



1. If a local headset will be used, plug it into the **HEADSET connector** on the front panel of the base station. **NOTE:** The connector is keyed, so the headset cable plug cannot be inserted in the wrong direction.
2. Press the **POWER switch** on the front panel to turn on the base station. A red light on the switch should go on.

# COMMUNICATOR® Setup and Registration

The first time you operate the DX410 system, you must register each Communicator (Belt Pack and/or All-In-One Headset) for use with a specific base station. The base station will then recognize all registered Communicators when their power is on and will differentiate between them and other electronic equipment operating on the same frequencies. If a Communicator is added or replaced later, the new one must be registered and the old one remains in memory. A maximum of 15 Communicators can be registered to a single base station at one time.

## Set Up COMMUNICATOR®s

Before registering them, set up all Communicators as follows:

### The Belt Pack

- Insert a fully charged battery in each Belt Pack with the metal contacts inserted first. Slide it in until it snaps.  
**NOTE:** The battery will not slide in if inserted incorrectly. Excessive force should not be necessary.
- Plug the belt pack's headset cable connector into each Belt Pack.

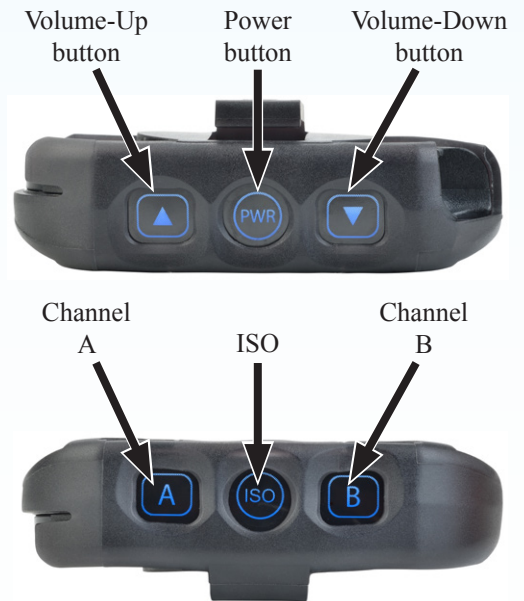

### Removing the battery

When a Communicator battery becomes weak, a headset voice prompt will say "Change battery."

Press the **RELEASE BATTERY button** on the belt clip of the pouch, and use your thumb to slide the battery from the belt-pac.



## All-In-One Headsets



### Changing Batteries

When a battery weakens, a prompt in the headset will say "Change battery". Remove the battery from the headset by pressing the blue battery-release latch.

Insert a fully charged battery in each Headset, with the battery's metal contacts inserted first. Press it in until it snaps.

**NOTE:** The battery will not slide in if inserted incorrectly. Excessive force should not be necessary.

### Adjust the Headset to Your Head Size

You can adjust the head size of the Headset by sliding the metal headband in or out of its plastic size adjuster.

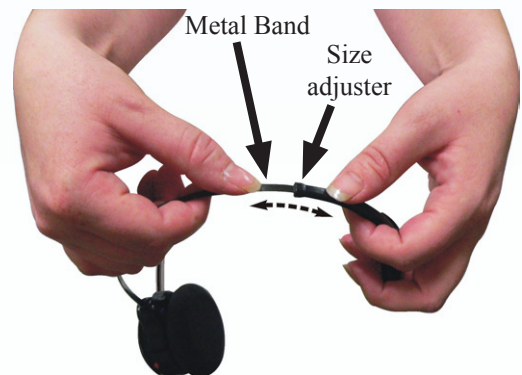

### Place the Headset on your head

1. The headset can be worn with the microphone and controls on either side of your head.
2. Hold the microphone boom at its base, and adjust it so that the microphone is near the side of your mouth.

## Register COMMUNICATOR®s

The Communicator must be within 6 feet (1.83 meters) of the base station to enable registration.

1. Be certain all headsets to be registered are turned OFF, and the base station power is ON.
2. Place the headset on your head.
3. Press the **REG button** on the front panel of the base station. The **STATUS** display will show a small “o” for open.

**NOTE:** If you wait too long before going on to the next step, the base station will exit registration mode, requiring that you press the **REG button** again.

4. Press and hold the **ISO button** on the Communicator while you press and release the **Power button (PWR)**. After power up, release the **ISO button**. The Communicator will enter Registration mode.

On **Belt Packs**, the two power lights at the corners near the **A** and **B** buttons will begin blinking red, and then they will blink green two or three times then turn off.

**Note:** There may be a short delay.

On **All-In-One Headsets**, the power/mode lights located at the end of the microphone boom and on the side of the unit near the **A** button will blink.

**Note:** There may be a short delay.

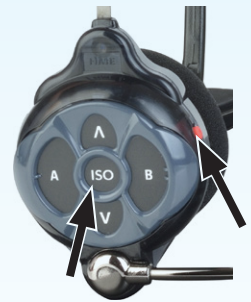

### If registration is successfully completed:

- A voice prompt in the headset will say “Battery level, begin registration...”.
- After a delay of about 15 seconds, the STATUS display will show the ID number assigned to the Communicator for about 10 seconds.

**NOTE:** ID numbers are assigned sequentially 0 through 9, then A, b, C, d and E.

- The power light on the Communicator will display steady green.



### If registration failed:

- A voice message in the headset will say “Battery level, begin registration...” Both lights on the Belt Pack will be blinking red, and there may be a delay of up to 90 seconds before you hear “Registration failed.”
- Press the **RESET button** at the lower-left corner of the base station with a pen or similar pointed object. When the STATUS display becomes blank, press the **REG button** and register the Communicator again. If registration fails again, call your dealer for assistance.



### If you try to register more than 15 Communicators:

- An “F” will appear on the STATUS display on the base station and you will hear “Registration failed” in the headset.
- Clear all current registrations by pressing the **CLR/BND button** and the **RESET button** at the same time. To press the **RESET button**, insert a pen or similar pointed object into the **RESET** hole at the lower-left corner of the base station front panel. Continue holding the **CLR/BND button** after you release the **RESET button**, until the clear code “c” (lower case) appears on the STATUS display.
- Register all active Communicators, one at a time. Previously registered Communicators must be re-registered.



## COMMUNICATOR® Settings

If you want to set up a Communicator with any of the special settings shown below, press and hold the specified button combinations during or after power up. These settings will remain in memory when the Communicators are turned off and on again.

For Setting	Press & Hold while you Press and Release the Power button
ISO restrict On	<b>A</b> button
ISO restrict Off	<b>A</b> and ISO buttons
Handsfree On selected button(s)	<b>A</b> and/or <b>B</b> and/or <b>ISO</b> and ▲ volume up button
Handsfree Off selected buttons(s)	<b>A</b> and/or <b>B</b> and/or <b>ISO</b> and ▼ volume down button
Listen-Only mode On	▼ volume down button
Listen-Only Off	▲ volume up button
<b>WH410 only *</b> All-In-One Headset "lights-off" mode	<b>B</b> button

\* **NOTE:** All-In-One Headsets can be set up with its indicator lights off, to avoid distraction if users are in an area visible to audience. This setting is not saved when you power off.

For Setting	With the power already on...
Increase mic gain (15 steps)	Press <b>B</b> while you repeatedly press the ▲ volume up button
Decrease mic gain (15 steps)	Press <b>B</b> while you repeatedly press the ▼ volume down button
<b>BP410 only *</b> Increase sidetone level (5 steps)	Press <b>A</b> while you repeatedly press the ▲ volume up button
<b>BP410 only *</b> Decrease sidetone level (5 steps)	Press <b>A</b> while you repeatedly press the ▼ volume down button

\* **NOTE:** There is no sidetone adjustment function for All-In-One Headsets.

If you are not connecting a wired intercom, go on to [System Operation](#) (pg. 20).



# Interfacing with 2-Wire or 4-Wire Intercoms



Base station rear panel

## 2-Wire Intercom Interface

The following 2-wire setup is for Channel 1 (A). If applicable, repeat for Channel 2 (B).

- If using a 2-wire intercom with the DX410, plug it into the base station 2-W connector at (2) or (3), depending on whether a male or female connection is required.
- Depending on whether you are using a Clear-Com® or RTS® compatible 2-wire intercom system, position the **CLEAR-COM / RTS button** (4) as follows: In position = RTS Mode Out position = Clear-Com Mode
- Press the **A SELECT button** on the front panel of the base station. The 2-W light next to the button should turn green.

**NOTE:** If no power is detected at the 2-W connector, the 2-W light will illuminate red and no audio will be passed through. Plugging a connection into a Clear-Com or RTS power supply will turn the light green and operation will begin.

- Make certain there are no open microphones on the wired intercom. If users are wearing headsets, please notify them of the impending audio sweep prior to auto nulling.
- Press and hold the **AUTO NULL button** for two seconds. To press the **AUTO NULL button**, insert a pen or similar pointed object into the AUTO NULL hole on the front panel of the base station. An audio sweep will be heard for 25 seconds on the wired Belt Packs. (The 2-W light next to the button should turn amber, then green.)
- Adjust the 2-W intercom receive and send levels with the A 2-W INPUT control and OUTPUT control.

**NOTE:** If you are not connecting other equipment, go on to [System Operation](#) (pg. 20).

## 4-Wire Intercom Interface

The following 4-wire setup is for Channel 1 (A). Repeat for Channel 2 (B) if applicable.

- If using a 4-wire intercom with the DX410, plug it into the base station A 4-W connector (1).
- Press the respective **SELECT button** until the A 4-W light next to the button goes on.
- Adjust the 4-wire intercom receive and send levels with the A 4-W INPUT and OUTPUT controls.

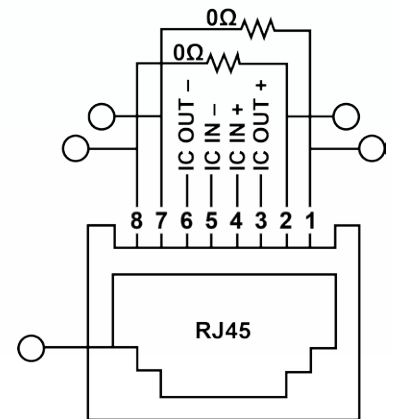

RJ45 Connector Pins	Designation
Pins 1, 2, 7 and 8	N/C (reserved)
Pin 3	Intercom Out +
Pin 4	Intercom In +
Pin 5	Intercom In -
Pin 6	Intercom Out -



## A and B Intercom Controls and Indicator Lights

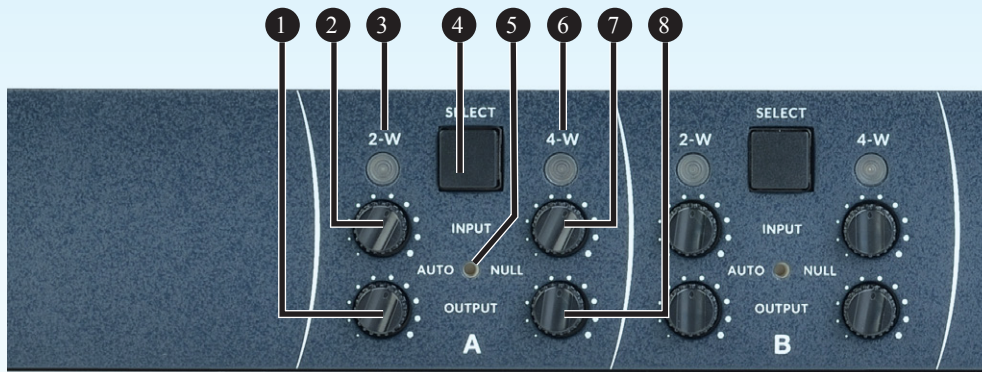

Base station front panel

The A portion of this area of the panel is for Intercom Channel A, and the B portion is for Intercom Channel 2. Their operation is identical.

- The **SELECT button** (4) is used to select 2-Wire (3) or 4-Wire (6) or both. The 2-W indicator light will display red (muted) if wired intercom power is not detected at the 2-W connector on the rear panel of the base station. The 2-W indicator light will display green if 2-W equipment which supplies power is plugged into the 2-W connector on the rear panel of the base station, or if the respective bypass jumper inside the unit has been set.
- The **INPUT controls** (2 and 7) are used to adjust the audio levels going to COMMUNICATOR<sup>®</sup>s or a local headset, coming in from 2-W and 4-W equipment connected to the base station.
- The **OUTPUT controls** (1 and 8) are used to adjust the audio levels coming in from Communicators or a local headset going out to 2-W and 4-W equipment connected to the base station.
- The **AUTO NULL button** (5) is used to eliminate echo caused by mismatched line characteristics of an external 2-W system.

**CAUTION:** Before pressing the **AUTO NULL button**, be sure there are no open microphones on the wired system. Use a pen or similar pointed object to depress and hold the **AUTO NULL button** for 2 seconds.

**NOTE:** If you are not connecting other equipment, go on to [System Operation](#) (pg. 20).

## Interfacing with Auxiliary Audio Equipment

ISO Audio can be routed to the AUX OUT connector for page or stage announce.

- If using auxiliary audio equipment, such as another intercom or an audio player, connect its output cable connector (male) to the AUX IN connector (9), and/or its input cable connector (female) to the AUX OUT connector (10).



Base station rear panel

The cable connectors must be 3-pin XLR type for balanced +20dBu Pin 1 = Ground maximum audio input/output, with Pin 2 = Audio + the following pin connections:

Pin 1 = Ground  
Pin 2 = Audio +  
Pin 3 = Audio -

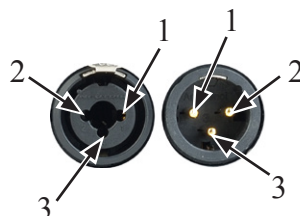

The **AUXILIARY SELECT button (2)** is used to select A or B or both as the destination for AUX IN audio. The A and/or B INPUT ASSIGN lights (1) come on green to indicate the selection as the destination for AUX IN audio. If neither is selected, AUX IN audio will not be routed to the COMMUNICATOR®s. The AUX IN light must be lit for the INPUT ASSIGN SELECT function to work.

- If only AUX IN is used, press the **AUX IN/OUT SELECT button (5)** until the IN light (4) turns on. Listen to the audio input in your headset as you adjust the INPUT control (3) to the desired level.
- If only AUX OUT is used, press the **AUX IN/OUT SELECT button (5)** until the OUT light (6) comes on. Check the audio level on the auxiliary equipment, and adjust the OUTPUT control (7) to the desired level.
- If the auxiliary equipment requires two-way communication, have someone listening at the auxiliary unit. Press the **AUX IN/OUT SELECT button (5)** until both the IN and OUT lights (4 and 7) turn on. While speaking into the headset microphone, adjust the OUT control (7) above the light to the desired listening level at the auxiliary unit. Listen to the audio input in your headset as you adjust the INPUT control (3) below the light to the desired level.

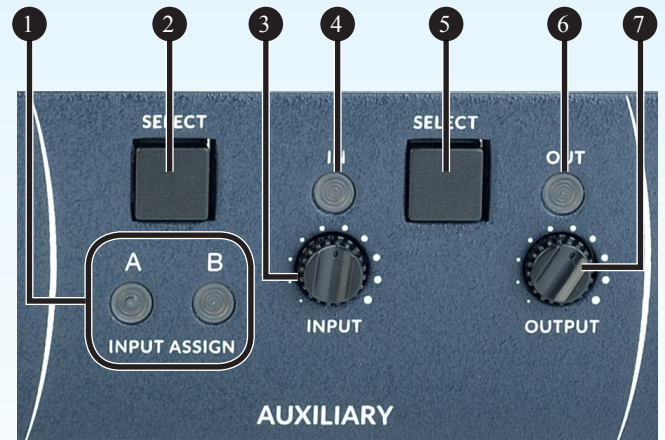

Base station rear panel

### Auxiliary Controls and Indicator Lights:

- The **SELECT button on the right (5)** is used to select AUX IN (audio from auxiliary equipment connected to the base station), AUX OUT (audio to the auxiliary equipment from the ISO channel of the COMMUNICATOR®s and local headset) or both.
- The IN and OUT lights illuminate green to indicate the selection.
- The INPUT and OUTPUT controls adjust auxiliary inbound and outbound audio levels.
- The **SELECT button on the left (2)** is used to select A or B or both as the destination for AUX IN audio. The A and/or B destination for AUX IN audio. INPUT ASSIGN lights come on green to indicate the selection as the destination for AUX IN audio.

**NOTE:** If you are not connecting other equipment, go on to [System Operation](#) (next page).

### ISO Relay

During ISO communication, a relay closure is provided. This can be used for tasks such as keying a long range radio or triggering an alert light. It can be activated from a Communicator or a local headset.

- 1 = Normally closed
- 2 = Common
- 3 = Normally Open
- 4 = not used
- 5 = Ground

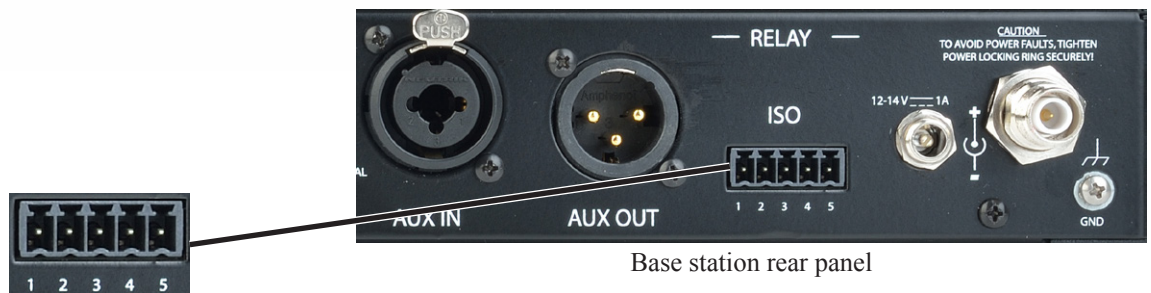

Base station rear panel

# SYSTEM OPERATION

This chapter describes how to operate the Base Station and COMMUNICATOR® (Belt Pack or All-In-One Headset).

## Base Station Operation

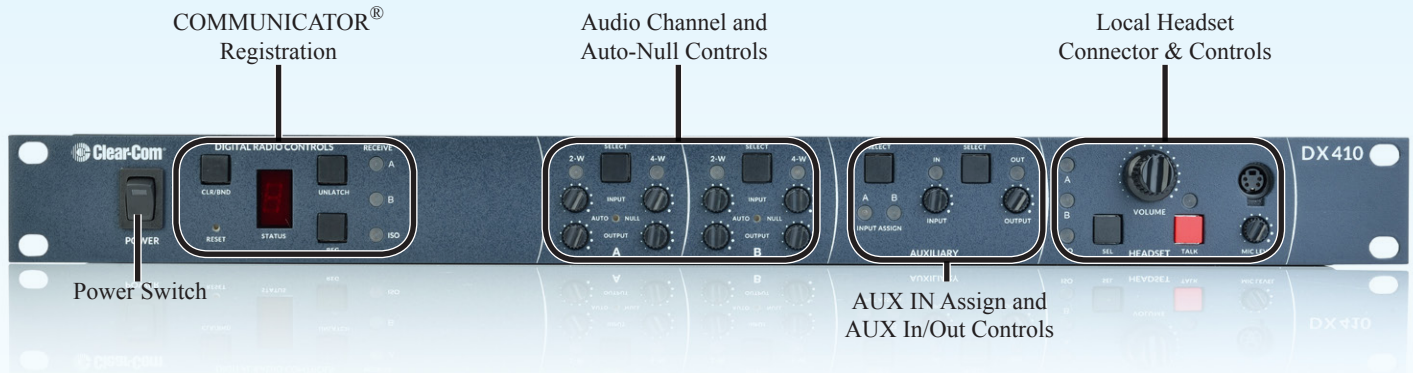

### System and Registration Controls and Indicator Lights

- ▶ The **CLR/BND** button, **RESET** button, **STATUS** indicator and **REG** button are used when registering Communicators. Refer to [COMMUNICATOR® Setup and Registration](#) (pg. 13).
- ▶ The **UNLATCH** button is used by the base station operator to turn off microphones on all Communicator transmitters.
- ▶ The **RECEIVE A, B** (Intercoms) and **ISO** (Isolate) lights indicate whether reception from a Communicator is on A, B or ISO.

### Local Headset Connector, Controls and Indicator Lights

- ▶ The **SEL** button (Select) is used to select communication from the local headset to A, B, A & B, or ISO.
- ▶ The A, B, A & B, or ISO indicator light will be lit for the selection you made.
- ▶ A and B communication will be heard by wireless users on the respective channel, as well as users wired into 2-W and 4-W connections.
- ▶ ISO is heard in both wireless channels, and AUX OUT if activated.



**NOTE:** When the ISO button is pressed, ISO RELAY is activated.

- ▶ The **TALK** button (red) is used for communication from the local headset to the selected channel. For open communication, press and release the **TALK** button quickly to “latch on.” To “latch off,” press and release the button again quickly.

For momentary communication, press and hold the **TALK** button for more than one second. In this mode, the selected channel will remain open only as long as you are pressing the **TALK** button. The TALK light indicates the TALK mode is active via the local headset.

- ▶ Use the **VOLUME** control to adjust the output to the local headset ear piece.
- ▶ Use the **MIC LEVEL** control to adjust the audio level from the local headset microphone.

# COMMUNICATOR® OPERATION

Belt Pack control buttons have a snap action. They will activate when pressed firmly. Use your fingertips (not your fingernails) to press the Belt Pack buttons. All-In-One Headset buttons are touch sensitive.

## Power On/Off

- **Power On** – Press and release the **Power button (PWR)**. A voice prompt in the ear piece will say “Battery Level”, and the red power lights near the corners of the A and B buttons will turn on. After a short time, one light will go off and the other will change to green, indicating the Belt Pack is ready for use. The STATUS indicator on the base station will momentarily indicate the ID of the Belt Pack. The green power light will be on steady whenever the Belt Pack is ready, but not transmitting.  
**NOTE:** While the Belt Pack is transmitting, the green power light will be flashing.
- **Power Off** – Press and hold the **PWR button** for approximately two seconds. A voice message in the ear piece will say “power off”, and the green power light will turn off.

## ISO (Isolate) and A, B (Intercom)

Use the **ISO button** to talk to other wireless Communicator users and the base station operator. Pressing **ISO** on the Belt Pack will also send audio to AUX OUT if the AUXILIARY OUT light on the front of the base station is on. Use the **A** and **B** buttons to communicate via the wired intercom channels and the base station operator. When the **ISO button** is pressed, ISO RELAY is activated.

## Operating Modes

- **Push-To-Talk ONLY Mode Operation** – In PTT operation, audio is transmitted only while you are pressing and holding the **A, B** or **ISO button**. When you release the button, transmission stops.
- **Hands-free Mode Operation** – Quickly press and release the **A, B** or **ISO button** to “latch” the transmitter on. Talk and listen, as in a normal telephone conversation. Quickly press and release the same button again to “unlatch,” and end the conversation. The base station operator can unlatch all Communicators by pressing the **UNLATCH button** on the base station.  
**NOTE:** In the hands-free mode, if you are latched in **A, B** or **ISO**, quickly pressing/releasing either of the other buttons will latch on that button.

Also in the hands-free mode, if you are latched in **A** or **B** and then press and hold the **ISO button**, it will function as PTT. When you release the **ISO button**, the Communicator will revert to the latched **A** or **B**.

Refer to Communicator indicator light functions, [Appendix A](#) (pg. 30).

## Volume Up/Down

- **Volume Up Adjustment** – Each time you press and release the volume-up **▲ button**, a beep will be heard in the ear piece as the volume increases one step. If you press and hold the **▲ button**, repeating beeps will be heard as the volume steps up to maximum. When maximum volume is reached, “maximum” will be heard in the ear piece, and it will be repeated until you release the **▲ button**.
- **Volume Down Adjustment** – Each time you press and release the volume-down **▼ button**, a beep will be heard in the ear piece as the volume decreases one step. If you press and hold the **▼ button**, repeating beeps will be heard as the volume steps down to minimum. When minimum volume is reached, rapidly repeating beeps will be heard.

## Adjusting Microphone Gain

Some users talk louder/softer than others. To allow for this, microphone gain adjustment is available.

- **To increase microphone gain** – While holding down the **B button**, press the volume-up ▲ button as many times as necessary to reach the desired level. The microphone gain increase can be monitored through side tone, or preferably by someone else using a Communicator or at the base station.
- **To decrease microphone gain** – While holding down the **B button**, press the volume-down ▼ button as many times as necessary to reach the desired level. The microphone gain decrease can be monitored through side tone, or preferably by someone else using a Communicator or at the base station.

**NOTE:** The mic gain setting will be indicated, in number format, by a voice prompt (typically, HS14 = 5, HS15 = 3, HS16 = 3). You will hear “Maximum” if you attempt to go higher than maximum mic gain. You will hear repeating beeps if you attempt to go lower than minimum mic gain. Microphone gain will be saved in memory and does not require readjustment each time the power is turned on. The Default setting is 3.

## Adjusting BP410 Belt Pack Side Tone

- **To increase side tone** – Press the volume-up ▲ button while holding down the **A button** in the normal operating mode.
- **To decrease side tone** – Press the volume-down ▼ button while holding down the **A button** in the normal operating mode.

**NOTE:** The side tone setting will be indicated in numbers by a voice prompt. Default setting is “Max”.

## Using WH410 All-In-One Headset Lights-Off Mode

The Lights-Off mode can be used to avoid audience distraction from the lights on the All-In-One Headsets.

- To operate in the Lights-Off mode, with the WH410 power off, press and hold the **B button** while you press the **POWER button**, and then release both buttons.
- To get out of the Lights-Off mode, power the WH410 off and back on again without pressing the **B button**.

**NOTE:** There is no side tone adjustment number for the All-In-One Headset.

## Changing COMMUNICATOR® Batteries

When a Communicator battery becomes weak, a prompt in the ear piece will say “Change battery”.



Press the **RELEASE BATTERY button** on the belt clip of the pouch, and use your thumb to slide the battery from the belt-pac.

**NOTE:** You do not need to remove the pouch to remove or insert the battery.



Remove the headset battery by pressing the blue battery-release latch, and use your thumb to slide the battery out.

# EU BASE STATION ADAPTIVE FREQUENCY HOPPING

## Background

The Clear-Com DX wireless intercom systems utilize a **Frequency Hopping Spread Spectrum (FHSS)** radio in order to provide robust communications.

This system operates in the unlicensed 2.4 GHz band. With the proliferation of other devices over the past few years in the same 2.4 GHz band, instances where these devices and systems can interfere with each other has greatly increased.

To further complicate matters, the European Union has introduced new radio standards for equipment operating in this band in an attempt to reduce interference between equipment from different manufacturers. This European Telecommunications Standards Institute (ETSI) harmonized European standard is known as EN 300 328.

## CLEAR-COM Adaptive Frequency Hopping

In order to reduce interference with other equipment and comply with these new regulations, Clear-Com has implemented an **Adaptive Frequency Hopping (AFH)** mode for the new DX EU base stations. The key idea behind AFH is using only the good frequencies, or channels, unoccupied by other equipment. The system scans for other signals and avoids these signals during operation. Since the radio environment is constantly changing, there is a continuous process of scanning for used frequencies and updating the list of good channels.

The Clear-Com system utilizes 46 discrete frequencies, or channels, within the 2.4 GHz spectrum in order to communicate voice and data. The process of deciding which channels should be used is a 3-stage process. The process includes scanning for occupied channels, the broadcast of a channel exclusion list and the use of the exclusion list. The process is completed in three steps coexisting in time.

Below is the process is shown in Time. First, the system performs a channel scan to determine occupied channels. This list is then broadcast to the communicator. The communicators and base station will use this list during period three. The process is continuous, and as is illustrated below, the list could be constantly changing. Depending on the radio environment, a maximum of 46 channels, and a minimum of 15 channels may be used by the system at any time.

**Time** ⇒

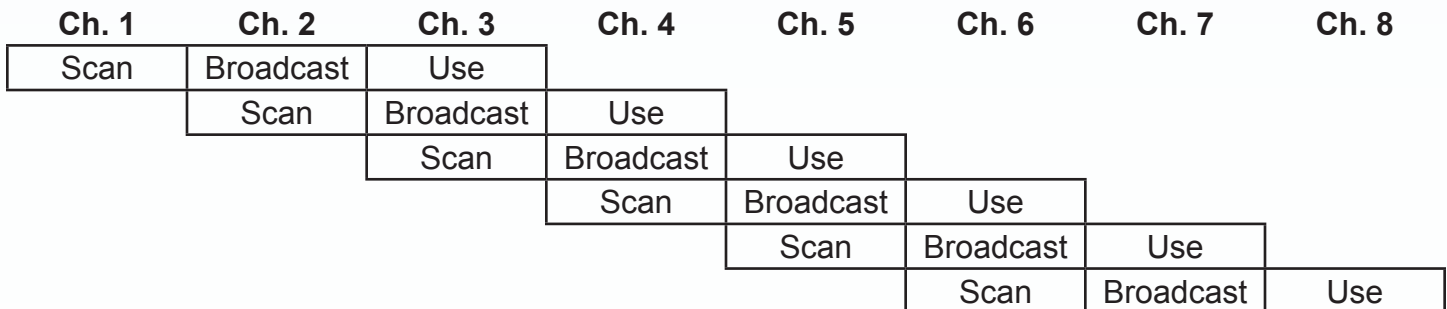

For instructions describing the process of setting the base to AFH or another scanning mode, see [Appendix D: Interference Avoidance Through Spectrum Friendly](#), pg. 33.

Available settings include:

**High (H)** - Scans the Higher frequencies.

**Low (L)** - Scans the Lower frequencies.

**All (A)** - All frequencies are scanned.

**AFH (E)** - (European Mode) Advanced Frequency Hopping searches for the best frequency.



## Operation in Severe Environments

During normal operation, the fact that the system is constantly changing the channel list in use is transparent to the user. It is possible, however, that in an environment with severe interference that the system may experience a slight degradation. In the AFH mode, the Clear-Com system will use a minimum of 15 channels. If the environment is very crowded and less than 15 channels are truly available, there could be increased radio 'packet loss' due to the high interference. The following symptoms may be observed with AFH systems in a highly congested radio environment:

- This may result in system 'busy' indications. Channel lists are updated every few seconds, and in a severe environment it is possible that these lists get missed by the communicator.
- Slight degradation in audio fidelity between the headsets and base station. This would be due to the same symptom as the 'busy' indications. The HD audio processing is tolerant to this condition, which is why the degradation may only be slight.
- Longer times to register. Registration may take longer, since the headset has to acquire the channel list from the base station. If the base station has excluded a lot of channels, this takes longer as the communicator does not have the exclusion list and looks for the base on channels it is not using.
- Initial sync time increase. For the same reason registration may take longer, the initial headset sync on power up may take longer.

## Required AFH Equipment

In order to utilize AFH, the base station must be set to European mode. The headsets and belt packs must also be AFH capable. AFH capable headsets and belt packs will have the letters 'AFH' labeled on the belt pack and headsets. AFH communicators will auto detect if the system is in AFH mode and adjust their operation accordingly.

## Non-AFH Equipment

Headsets and belt packs that are not AFH capable must be operated with either a non-AFH base station or an AFH base station selected to operate in All, High or Low band mode. Headsets and belt packs that are not AFH capable will not have the letters 'AFH'.

## AFH Model Chart

Order #	Model #	AFH Part #	Comments
CZ-BP410	BP410	G29382-2A13	ALL BP410 Beltpacks are AFH compatible.
CZ-WH410	WH410	G29090-6B43	ALL WH410's are AFH compatible.

Part number is located on label under the battery on beltpacks and wireless headsets

## Interference Mitigation

Certain techniques can be used in an attempt to mitigate interference between different equipment in the 2.4 GHz spectrum. Some of these are:

- **Physical separation.** If possible, equipment operating in the 2.4 GHz spectrum should be operating as far as physically possible from the HME base station. A Wi-Fi access point or router is a common piece of equipment that could interfere with the DX410 system, or vice versa. These two pieces of equipment in particular should not be located close together.
- **Spectral separation.** Most Wi-Fi access points allow the administrator to set the channel and bandwidth that system operates on. Some systems employ an 'auto' mode, in which the Wi-Fi access point will automatically selected the channel. With Wi-Fi access points, it is sometimes advantageous to manually select a channel number to keep the Wi-Fi transmission at a fixed location.

**NOTE:** If the Clear-Com system does not have AFH, then the base station should be set to operate in the region of the 2.4 GHz band where the Wi-Fi access point is not operating. For example, if the Wi-Fi access point is set to Wi-Fi channel 1, the base station should be set to operate in the 'High' band. If the Wi-Fi access point is set to channel 11, the base should be set to operate in the 'Low'.



- **Spectral efficiency.** Wi-Fi systems employ a standard sometimes referred to as 802.11. The number “11” is simply the number given to the standard by the Institute of Electrical and Electronics Engineers (the IEEE). Modern Wi-Fi routers will allow operation employing the 802.11n mode. This mode will allow higher data rates, but it also may consume twice the number of radio channels. If the Wi-Fi router is set to 802.11n mode, it is best to limit Wi-Fi bandwidth to 20 MHz.
- **Alternate band selection.** While most Wi-Fi systems operate at 2.4 GHz, which is the same band as the DX410 system. Most allow operation at 5 GHz. If possible, move any Wi-Fi access points and equipment to 5 GHz. This of course requires all Wi-Fi equipment to be 5 GHz capable, and most older equipment may only allow 2.4 GHz operation. Selection of 5 GHz may also not be desirable if the Wi-Fi network is for customer access.

## Non-Overlapping Channels for 2.4 GHz WLAN

### 802.11 channel width 22 MHz

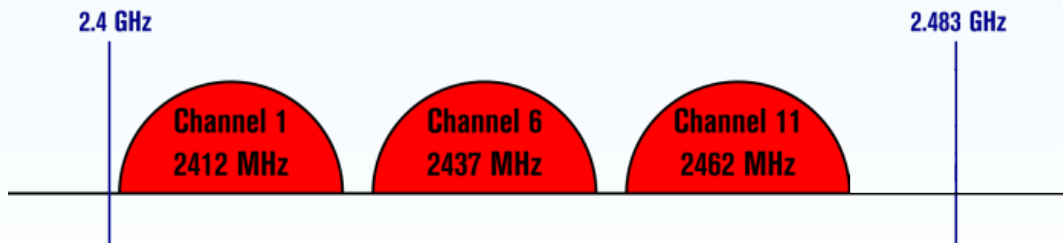

### 802.11 40 MHz ch. width

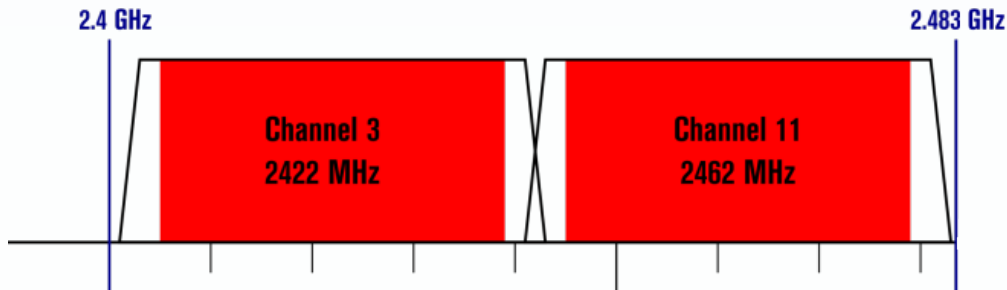

## TROUBLESHOOTING

Problem	THINGS TO CHECK
<b>The Red light on base station power switch does not come on.</b>	Be sure the power cords are properly connected to base station, power supply and electrical outlet.
<b>The Belt Pack power lights do not turn green and “out of range” is heard in the headset.</b>	Be sure your base station power is on. Turn the Belt Pack and base station power on and off. You may be too far from the base station. The range varies with each location’s layout.
<b>When trying to register, you keep hearing “registration failed”.</b>	Refer to “If registration failed” in section 2.3.2, page 8, and repeat the registration procedure. If “F ” shows up on the STATUS display, it indicates that an attempt has been made to register more than 15 Belt Packs. Follow the related instructions in section 2.3.2, page 9.
<b>Others cannot hear me when I talk.</b>	Be sure the headset is securely connected to the Belt Pack or base station, and that you are pressing the A, B or ISO button on the Belt Pack, or the TALK button on the base station. Be sure the appropriate A, B or ISO setting is selected in the HEADSET section of the base station front panel.
<b>People on the 4-wire intercom cannot hear me, or I cannot hear them.</b>	Be sure the cables are securely connected and the 4-wire intercom is on. If using a local headset, be sure the desired IC setting is selected in the HEADSET section of the base station front panel. If using a Belt Pack or All-In-One Headset, press the desired IC button.
<b>People on the RTS®/Clear-Com® systems cannot hear me, or I cannot hear them.</b>	Be sure the cables are securely connected and the 2-wire intercom is on. If using the local headset, be sure the desired IC setting is selected in the HEADSET section of the base station front panel. If using a Belt Pack or All-In-One Headset, press the desired IC button.
<b>The 2-wire intercom is on, and there is a loud squeal whenever I try to talk.</b>	This can occur if two or more base stations are daisy-chained without terminating the appropriate channel. The termination is set by putting JP5 (A) and/or JP6 (B) in the ON position. This should be done in only one base station. Refer to <a href="#">Appendix C</a> , page 32, for jumper (JP) locations.
<b>Settings are not retained when the base station power is turned off and then back on.</b>	The internal battery may be low. Contact your dealer.
<b>2-W LEDs remain red. No 2-wire power detected.</b>	Plug into 2-W power supply. If the lack of powered 2-W system is intentional (such as when using a Clear-Com MT1, or when daisy-chaining multiple base stations), open the base station cover and set JP1 (A) and/or JP2 (B) to the ON position. If daisy-chaining, do not forget to also terminate one of the base stations by setting JP5 (A) and/or JP6 (B) to ON. Refer to <a href="#">Appendix C</a> , page 32, for jumper (JP) locations.
<b>Echo on 2-W line.</b>	Be sure no wired Belt Packs have open mics and that the line is terminated, and rerun Auto Null.

## TECHNICAL DATA

### BS410 Base Station Specifications

<b>General</b>	
<b>Channels</b>	2 audio channels
<b>Frequency Range</b>	2400 – 2483.5 MHz
<b>Frequency Response</b>	200 Hz to 7 kHz
<b>Power Requirements</b>	100-240VAC, 50-60Hz or 12-14VDC
<b>Temperature Range</b>	32-122°F (0-50°C)
<b>Size</b>	19" x 1.72" x 17.13" (1-RU) (48.26 x 4.37 x 43.51 cm)
<b>Weight</b>	9.0 lbs. (4.1 kg) maximum
<b># of COMMUNICATOR®s per Base</b>	15 can be registered. In single-channel operation, 4 can have simultaneous full-duplex communication. In dual-channel operation, 3 can have simultaneous full-duplex communication.
<b>4-Wire I/O</b>	RJ45, 600Ω balanced, level adjustable, simultaneous operation with 2-wire
<b>2-Wire I/O</b>	XLR-3M, XLR-3F, externally-switchable RTS® or Clear-Com® mode, 200Ω, level adjustable, null adjustable to 50dB attenuation, typical
<b>Auxiliary Input</b>	XLR-3F/¼" (6.35 mm) combo jack, 600Ω balanced, level adjustable
<b>Auxiliary Output</b>	XLR-3M, 600Ω balanced, level adjustable
<b>Headset Connector</b>	4-pin mini-DIN, Electret microphone
<b>Headset Output</b>	200mW into 32Ω
<b>Antenna Type</b>	External ½ -wave dipole (R-TNC connector), RX/TX horizontal/vertical diversity
<b>System Distortion</b>	<2%
<b>Communication Security</b>	Dual-slot diversity
<b>Base Station Transmitter</b>	
<b>Type</b>	Frequency Hopping, Spread Spectrum (FHSS)
<b>Transmit Power</b>	100mW burst
<b>Modulation Type</b>	Gaussian filtered FSK, TDMA
<b>Frequency Stability</b>	13 ppm
<b>Harmonics/Spurious</b>	Exceeds FCC and ETSI specifications over temperature
<b>Base Station Receiver</b>	
<b>Type: RF Sensitivity</b>	Frequency Hopping, Spread Spectrum <-90dBm w 10-3 BER
<b>Frequency Stability</b>	13 ppm
<b>Distortion</b>	<2%

## BP410 Belt Pack Specifications

<b>General</b>	
<b>Channels</b>	2 audio channels
<b>Frequency Range</b>	2400 – 2483.5 MHz
<b>Antenna</b>	Internal, horizontal/vertical diversity
<b>Frequency Response</b>	200 Hz to 7 kHz
<b>Battery Requirements</b>	3.6V lithium ion
<b>Battery Life</b>	Up to 20 hours
<b>Temperature Range</b>	32-122°F (0-50°C)
<b>Weight</b>	7.4 oz (.21 kg) with battery and pouch
<b>Headset Connector</b>	4-pin, mini-DIN
<b>Microphone</b>	Electret
<b>Headset Output</b>	160mW into 32Ω
<b>Controls</b>	Power, Volume-up, Volume-down, A, B, ISO
<b>Indicators</b>	Dual-color LED (red/green)
<b>System Distortion</b>	<2%
<b>Belt Pack Transmitter</b>	
<b>Type</b>	Frequency Hopping, Spread Spectrum
<b>Transmit Power</b>	100mW burst Transmission
<b>Modes</b>	Momentary or latch
<b>Modulation Type</b>	Gaussian filtered FSK, TDMA
<b>Frequency Stability</b>	13 ppm
<b>Harmonics/Spurious</b>	Exceeds FCC and ETSI specifications
<b>Belt Pack Receiver</b>	
<b>Type: RF Sensitivity</b>	Frequency Hopping, Spread Spectrum <-90dBm w 10-3 BER
<b>Frequency Stability</b>	13 ppm
<b>Distortion</b>	<2%

## WH410 All-In-One Headset Specifications

<b>General</b>	
<b>Channels</b>	2 audio channels
<b>Frequency Range</b>	2400 – 2483.5 MHz
<b>Antenna</b>	Internal
<b>Frequency Response</b>	200 Hz to 7 kHz
<b>Battery Requirements</b>	3.6V lithium ion
<b>Battery Life</b>	Up to 20 hours
<b>Temperature Range</b>	32-122°F (0-50°C)
<b>Weight</b>	5.7 oz (.16 kg) with battery
<b>Microphone</b>	Electret
<b>Headset Output</b>	160mW into 32Ω
<b>Controls</b>	Power, Volume-up, Volume-down, A, B, ISO
<b>Indicators</b>	Dual-color LED (red/green)
<b>System Distortion</b>	<2%
<b>Belt Pack Transmitter</b>	
<b>Type</b>	Frequency Hopping, Spread Spectrum
<b>Transmit Power</b>	100mW burst <b>Transmission</b>
<b>Modes</b>	Momentary or latch
<b>Modulation Type</b>	Gaussian filtered FSK, TDMA
<b>Frequency Stability</b>	13 ppm
<b>Harmonics/Spurious</b>	Exceeds FCC and ETSI specifications
<b>Belt Pack Receiver</b>	
<b>Type: RF Sensitivity</b>	Frequency Hopping, Spread Spectrum <-90dBm w 10-3 BER
<b>Frequency Stability</b>	13 ppm
<b>Distortion</b>	<2%

## APPENDIX A: COMMUNICATOR® Indicator Light Functions

### BP410 Belt Pack Indicator Lights

BP410 Condition	A Indicator Light	B Indicator Light
A Idle	Steady Green	OFF
A TX	Blinks Green	OFF
B Idle	OFF	Steady Green
B TX	OFF	Blinks Green
ISO TX	Blinks Green	Blinks Green
Low battery	Appropriate channel light Blinks Red when in idle mode	

### WH410 All-In-One Headset Indicator Lights

BP410 Condition	A Indicator Light	B Indicator Light
A Idle	Steady Green	OFF
A TX	Blinks Green	Steady Green
B Idle	Steady Red	Off
B TX	Blinks Red	Steady Green
B	Blinks Red or Green (depending on previous Mode)	Steady Red
Low battery	No indication	

# APPENDIX B: MULTIPLE BASE STATION DAISY-CHAINING

Two or more DX410 base stations can be “daisy-chained” together with cables connected to the 2-W connectors on the rear panels of each base station (following Clear-Com® / RTS® standards), or two base stations (not more) can be “daisy-chained” together with cables connected to the 4-W or AUX connectors.

A maximum of 4 base stations can be used in one system, spaced apart a minimum of 12 inches.

**NOTE 1:** DX410 does not provide 2-wire line power, therefore, 2-wire power bypass must be used.

RTS® Mode	Clear-Com® Mode
Pin 1 = Common	Pin 1 = Common
Pin 2 = Channel 1	Pin 2 = N/C
Pin 3 = Channel 2	Pin 3 = Audio

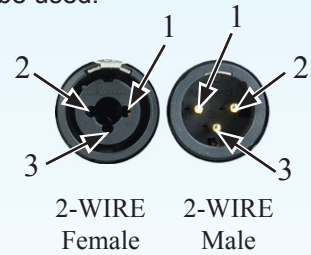

**NOTE 2:** For AUX type daisy-chaining, the cable connectors must be 3-pin XLR.

- If using 4-wire connection, use cable with In/Out crossed, as shown to the right. (An Ethernet crossover cable will not work.)
- If using 2-Wire connections, open each base station and set jumpers JP1 (A) and/or JP2 (B) in all base stations to ON for power detect bypass. Set jumpers JP5 (A) and/or JP6 (B) in only one base station per channel for termination. Refer to [Appendix C](#), next page.

A/B In +	—	A/B Out +
A/B In -	—	A/B Out -
A/B Out +	—	A/B In +
A/B Out -	—	A/B In -

## 2 Base Stations | More than 2 Base Stations

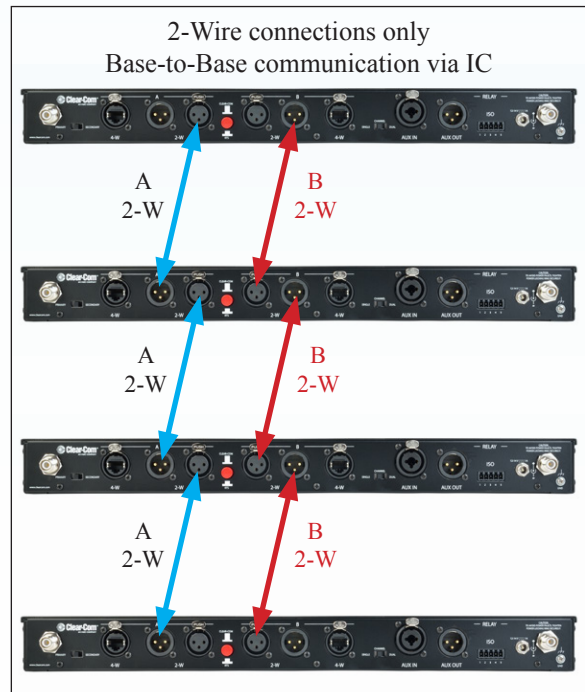
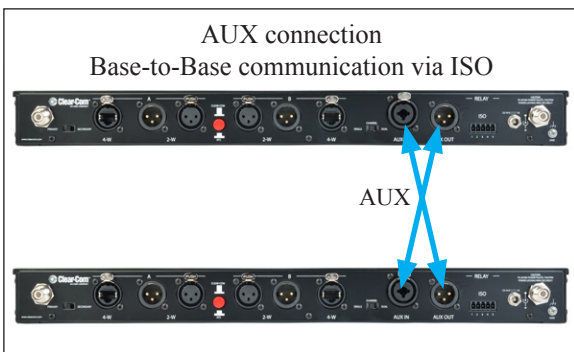
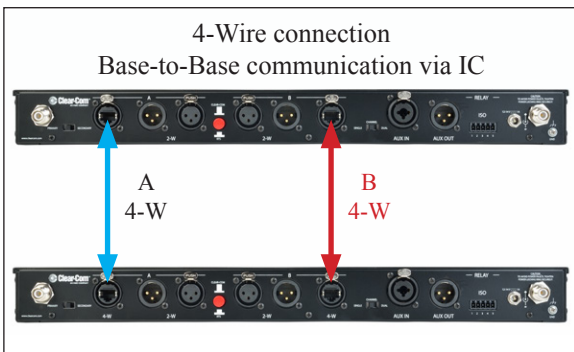
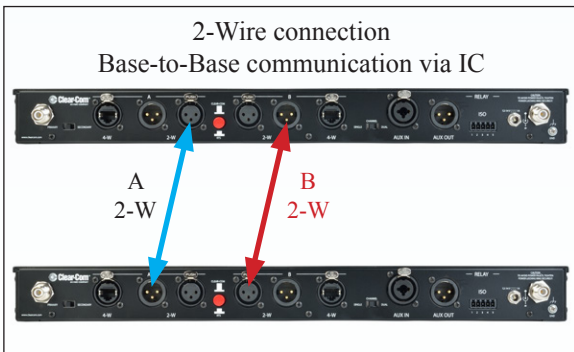

## APPENDIX C: JUMPER SETTINGS

The base station has internal jumpers that are used to set ISO broadcast restrict, power detect by-pass, and 2-wire channel termination.

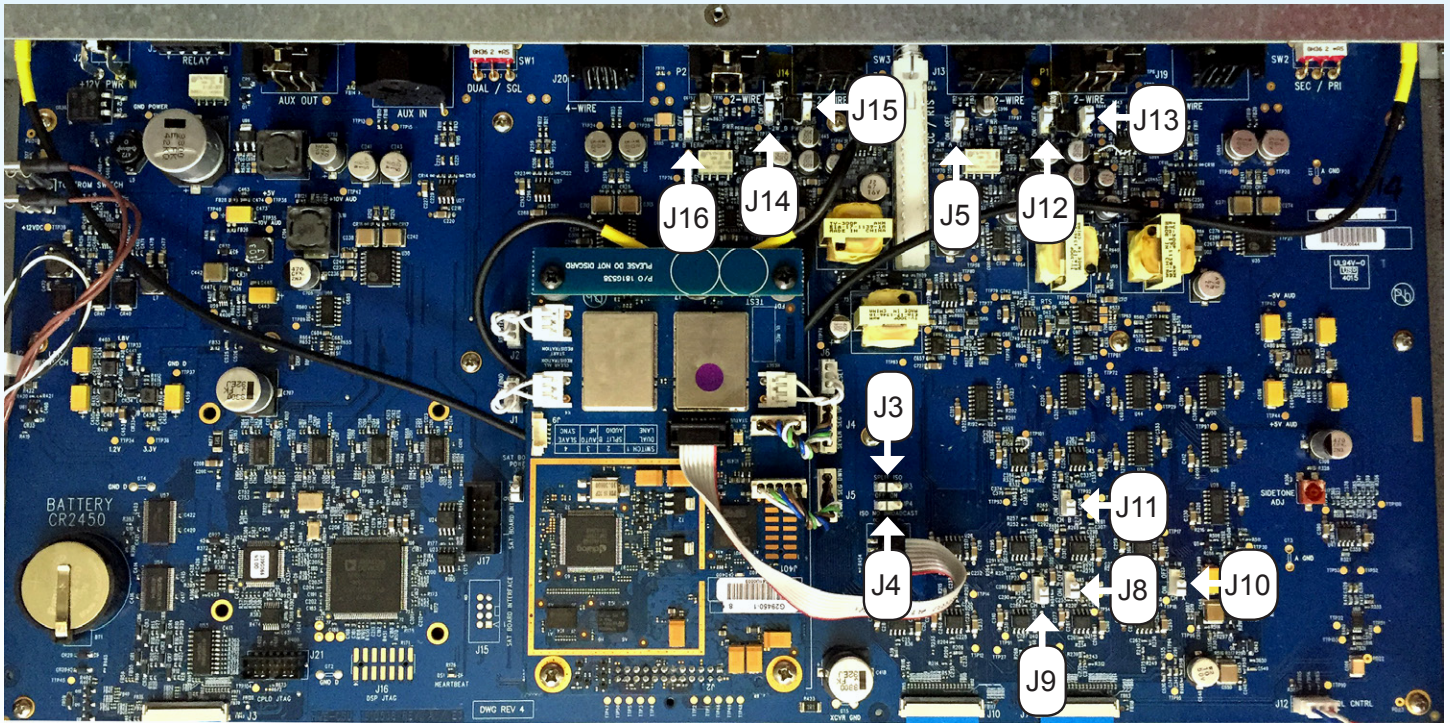

Jumper #	Function	Default
JP3	Split 'ISO'	Off
JP4	ISO No Broadcast	Off
JP5	Channel A, 2-wire termination	Off
JP8	Ch A 4w to 2w audio bridge	On
JP9	Ch B 4w to 2w audio bridge	On
JP10	Ch A 2w to 4w audio bridge	On
JP11	Ch B 2w to 4w audio bridge	On
JP12, JP13	2WA Power	Off
JP14, JP15	2WB Power	Off
JP16	Channel B 2- Wire Termination	Off

### ISO Broadcast Restrict

This feature prevents ISO communication from being broadcast from one COMMUNICATOR® to other Communicators. Local headset ISO will still be broadcast, and the local headset will still receive ISO communication. To enable this feature, set JP4 to ON.

**WARNING!** If no termination is present on the line, enabling this feature will cause feedback in the headsets.

### 2-Wire Channel Termination

If termination of the base station is necessary (such as when multiple base stations are daisy chained), set the JP5 (A) and/or JP6 (B) jumpers to the ON position on one base station, when connecting multiple base station together via 2-wire connection. Only one base station should be terminated per channel.



## APPENDIX D: INTERFERENCE AVOIDANCE THROUGH SPECTRUM FRIENDLY

Interference, which may be heard in a headset as popping sounds, may occur whenever other equipment such as Wi-Fi systems or wireless DMX systems use the same frequency band. Some systems can be limited to one portion of the band. If so, the DX410 can be set to the opposite half of the 2.4 GHz to 2.48 GHz band. To avoid this type of interference, select the upper or lower part of the frequency range.

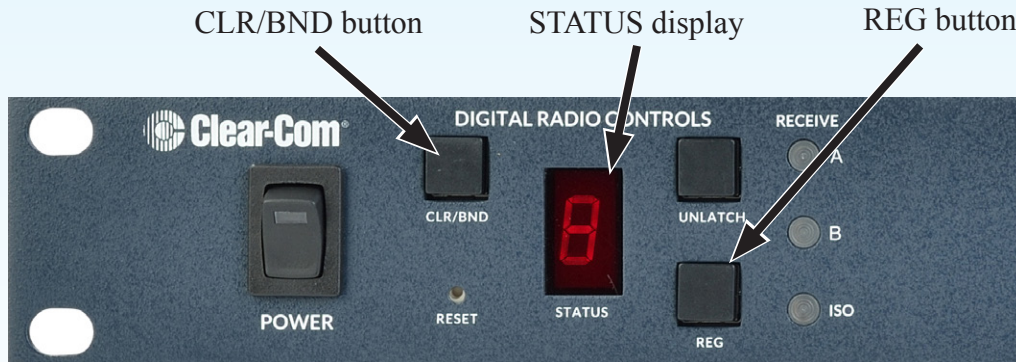

1. Power up the base station. An "8" will appear on the STATUS display for a few seconds.



Once the "8" disappears and the STATUS display is blank (primary base station) or shows a double bar (secondary base station), press and hold the **CLR/BND** button.



While you are still holding the **CLR/BND** button, press and hold the **REG** button and wait until a **L**, **H**, **A** or **E** appears. Release both buttons. Base stations are shipped in the **A** (default) position.

**NOTE:** The EU version of the base station is shipped in AFH mode **E**.



2. Press the **CLR/BND** button to cycle through parts of the frequency band, (**L** = Low end, **H** = High end, **A** = All and **E** = AFH), and stop on the desired setting.



<p>4. Wait until “c” appears on the display.</p> <p><b>NOTE:</b> A “c” will only appear on the STATUS display if you are setting the frequency band the first time, or you are changing the setting.</p> <p>If you stop at <b>L</b>, <b>H</b> or <b>A</b> that was already set, an “8” will appear for a few seconds and the STATUS display will become blank.</p>	 <p>DIGITAL RADIO CONTROLS</p> <p>CLR/BND      UNLATCH</p> <p>RESET      STATUS      REG</p>
<p>5. Register all COMMUNICATOR®s to be used with each base station as instructed on <a href="#">page 15</a>.</p> <p><b>NOTE:</b> If you change a base station’s frequency band setting, you will have to re-register all Communicators that were registered to that base station.</p>	 <p>DIGITAL RADIO CONTROLS</p> <p>CLR/BND      UNLATCH</p> <p>RESET      STATUS      REG</p> <p><b>Small “o” indicates Primary base station is open for registration</b></p>

### Spectrum Friendly

All DX Series wireless intercom systems now feature Spectrum Friendly™ technology for interference-free operation in the increasingly crowded 2.4GHz frequency band. This new technology enables broadcast and theatrical production crews to avoid emerging frequency conflicts by designating the 2.4GHz operating frequency range: **low-band**, **high-band** or **full-band**.

While generally not a problem when separated, multiple applications and multiple users of the same applications in close proximity can result in additional risk for trouble-free operation. The new technology further ensures that products do not add interference to the spectrum for other essential wireless services in the vicinity, such as DMX-controlled lighting.

### Avoiding Wi-Fi Interference

To avoid interference with Wi-Fi systems, it is recommended to set the Wi-Fi system to something other than channel 6 or 7. Your DX410 should be set to the high or low band opposite any Wi-Fi frequency range in use.

	DX410 Low Band = 2.4000-2.4400 GHz							DX410 High Band = 2.4433-2.4830 GHz							
Channel	1	2	3	4	5	6	7	8	9	10	11	12	13	14	
Wi-Fi Frequencies	2.412	2.417	2.422	2.427	2.432	2.437	2.442	2.447	2.452	2.457	2.462	2.467	2.472	2.484	GHz

**Note:** This feature is not available when the base station is in AFH mode.



## DX SERIES LED AID



Powering on any DX base station will produce on the LED display the number “8” for approximately 3 seconds.



Blank display indicates the base is ready for operation.

**You can register belt packs under this condition.**



Single horizontal bar indicates the base is in secondary mode and registering to a base has been initiated and successfully linked with a primary base. **You can register belt packs in this mode.** However, if the primary base is not present or turned off you **cannot**.



Two horizontal bars indicate that the base is in secondary mode and ready to be synced with a primary base. **You cannot register belt packs in this mode you must sync to a primary base first.**



Three horizontal bars indicate the base is in secondary mode and has been linked with a primary base but the primary base is **no longer** available to the secondary. It takes a few seconds for the secondary to recognize that the primary is not available and revert to a primary state. **However, you can register belt packs under this condition.**

## Syncing Primary to Secondary Bases Feature

To sync the bases, perform the following steps:

- Press the **REG** or **REGISTER BELT-PAC\*** button on the primary base and then press the **REG** or **REGISTER BELT-PAC\*** button on the secondary base to begin the sync process.
- As you repeatedly press the **REG** or **REGISTER BELT-PAC\*** button on the secondary you will see the numbers 1, 2, and 3 cycle through on the display. The numbers indicate the three available quadrants. **Note: The primary is in the 0 quadrant by default.**
- To select a quadrant, simply release the button at a desired number and wait for a blank display. For additional secondary bases assign each base to its own quadrant. If successful, you will see the single horizontal bar in the secondary LED display. Refer to the appropriate equipment manual for primary to secondary conversion.

After the bases are synced when the secondary is powered up the number “8” will appear followed by one of the numbers below on the secondary base LED display:



The number “1” indicates the quadrant the secondary has been placed in.



The number “2” indicates the quadrant the secondary has been placed in.



The number “3” indicates the quadrant the secondary has been placed in.

### NOTE

\* Button has the same function but with a different description on the equipment due to vintage.



The lower case "c" will appear when the registry on the base station is cleared. To clear the registry power down the base. Hold down the **CLR/BND** or **RESET REGISTRATION\*** button first and then power the base on when you see the "8" on the LED display release the **CLR/BND** or **RESET REGISTRATION\***. If done successfully you will see a small "c" on the LED display.

**NOTE: The display indicates that the registry of a base station has been cleared of all belt-pacs and secondary base stations that were registered to the base station.**

Another method to clear the registry would be to start by holding down the **CLR/BND** or **RESET REGISTRATION\*** button first and then pressing the **RESET** button until you hear a small click and then release the **CLR/BND** or **RESET REGISTRATION\*** button. If done successfully you will see a small "c" on the LED display. We recommend you use a very small paper clip.



The lower case "o" will appear when the **REG** or **REGISTER BELT-PAC\*** button is pressed and indicates that the base is ready to register a belt-pac.

When registering belt-pacs on DX bases that can carry 15 belt-pacs please note that the numeric count displayed on the LED will be in hexadecimal. This means that the LED will represent the first 10 belt-pacs as 0 to 9. Belt-pac 11 will be represented by the letter "A", belt-pac 12 will be represented by the letter "B" and on up to belt-pac 15 as "E". Please see below.

Beltpac	1	2	3	4	5	6	7	8	9	10	11	12	13	14	15
Registry	0	1	2	3	4	5	6	7	8	9	A	B	C	D	E



The letter "F" will appear when the base registry is at its maximum of 15 registered belt packs. You will need to clear the registry to add a belt-pac. To clear the registry power down the base. Hold down the **CLR/BND** or **RESET REGISTRATION\*** button first and then power the base on when you see the "8" on the LED display release the **CLR/BND** or **RESET REGISTRATION\***. If done successfully you will see a small "c" on the LED display.

## Spectrum Friendly Feature

**Spectrum Friendly option:** Hold down the **CLR/BND** (or **RESET REGISTRATION\***) button first then press and hold down the **REG** (or **REGISTER BELTPAC\***) button till you see the letter "A" or "L" or "H". Then release both buttons and quickly press the **CLR/BND** (or **RESET REGISTRATION\***) to cycle through the "A" or "L" or "H". options. Stop at your selection and wait for the LED display to go blank and a lower case "c" will appear on the status LED. After this procedure is performed all bases, belt-pacs and communicators will need to be re-registered to the base.



2400 to 2483.5 MHz is the operating frequency range.



2401.92 to 2439.94 MHz is the operating frequency range.



2443.39 to 2481.41 MHz is the operating frequency range.

### NOTE

\* Button has the same function but with a different description on the equipment due to vintage.

# APPENDIX E: AUDIO ROUTING DIAGRAM

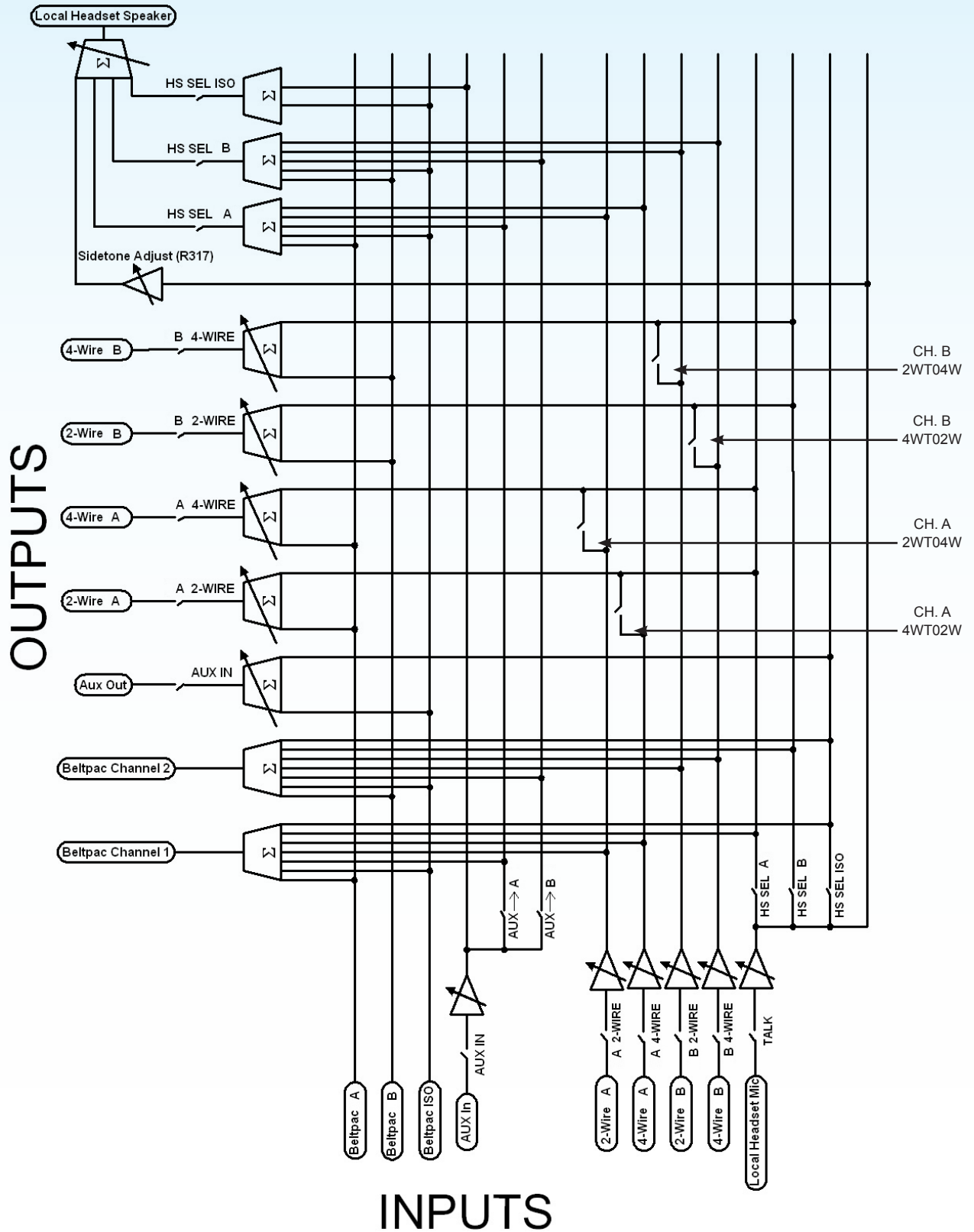

# GENERAL BATTERY SAFETY INSTRUCTIONS FOR BATTERY MODEL BAT41, BAT50, BAT60

BAT50 is specifically designed only for use with product(s) offered by:

HM Electronics Inc. (HME)

Clear-Com LLC, an HME Company

## SAFETY PRECAUTIONS

To ensure the safety and reliability of your Battery, follow the guidelines in this section.

### Using the Battery



#### **WARNING!**

#### **Do Not Abuse/Modify Battery Packs**

Lithium-ion cells and battery packs may get hot, explode or ignite and cause serious injury if modified or abused.

#### **Follow the safety instructions below:**

- Do not place the battery in fire or heat the battery.
- Do not connect the battery backward, so the polarity is reversed.
- Do not connect the positive terminal and negative terminal of the battery to each other with any metal object (such as a wire).
- Do not carry or store the battery together with necklaces, hairpins or other metal objects.
- Do not pierce the battery with nails, strike the battery with a hammer, step on the battery or otherwise subject it to strong impacts or shocks.
- Do not solder directly onto the battery.
- Do not expose the battery to water or salt water, or allow the battery to get wet.
- Do not disassemble or modify the battery. The battery contains safety and protection devices which, if damaged, may cause the battery to generate heat, explode or ignite.
- The protection circuit module provided with battery packs is not to be used as a substitute for a shutoff switch.
- Do not place the battery in or near fire, on stoves or in other high temperature locations.
- Do not place the battery in direct sunlight, or use or store the battery in cars in hot weather. Doing so may cause the battery to generate heat, explode or ignite. Using the battery in this manner may also result in a loss of performance or shortened life expectancy.
- When the battery is worn out, insulate the terminals with adhesive tape or a similar non-conducting material before disposal.

- Immediately discontinue use of the battery if, while using, charging, or storing the battery, the battery emits an unusual smell, feels hot, changes color or shape or appears abnormal in any other way.
- Do not place the battery in microwave ovens, high-pressure containers or on induction cookware.



#### **WARNING!**

In the event the battery leaks and the fluid gets into one's eye, do not rub the eye. Rinse well with water and immediately seek medical care. If left untreated, the battery fluid could cause damage to the eye.



#### **WARNING!**

If the device causes abnormal current to flow, it may cause the battery to become hot, explode, or ignite causing serious injury.

### Charger Types

Your battery must only be charged with a HME/Clear-Com recommended charger. Any attempt to use other types of chargers may cause an explosive reaction, fire or chemical burns. Do not assume that the physical form of another battery qualifies the charger for use with the HME/Clear-Com 104G041LF battery.

### Charging the Battery

Be sure to follow the warnings listed below while charging the battery. Failure to do so may cause the battery to become hot, explode or ignite and cause serious injury.

- Do not continue charging the battery if it does not recharge as specified HME/Clear-Com User Guide, under charging instructions.
- Do not attach the battery to an external charger, power supply plug or directly to a car's cigarette lighter.

### Recycling the Battery

If your business or household does not have a battery recycling program, go to the following URL or copy and paste the following URL into your browser, then enter your zip code for a list of recycling centers:

<http://earth911.com>

# DIRECTIVES DE SÉCURITÉ GÉNÉRALES POUR LES MODÈLES DE BATTERIE SUIVANTS : BAT41, BAT50, BAT60

Les batteries BATXX sont spécialement conçues de manière à ne pouvoir être utilisées qu'avec les produits offerts par

HM Electronics Inc. (HME), Clear-Com LLC, une société HME

## PRÉCAUTIONS

En vue d'assurer la sûreté et la fiabilité de votre batterie, respectez les directives indiquées dans cette section.

### Utilisation de la batterie



#### ATTENTION !

**Ne pas faire un usage abusif des blocs-piles ni les modifier**

Les cellules de lithium-ion et les blocs-piles peuvent devenir chauds, exploser ou prendre feu et ainsi causer des blessures graves si on en fait un usage abusif ou qu'on les modifie.

### Respectez les directives de sécurité ci-dessous :

- Ne pas placer la batterie dans le feu ni la faire chauffer.
- Ne pas brancher la batterie à l'envers de manière à ce que la polarité soit inversée.
- Ne pas connecter la borne positive et la borne négative de la batterie l'une à l'autre avec un objet de métal (comme du fil de fer).
- Ne pas transporter ni entreposer la batterie avec des colliers, des épingles à cheveux et d'autres objets de métal.
- Ne pas percer la batterie avec des clous, la frapper avec un marteau, marcher dessus et la soumettre de quelque autre manière que ce soit à des impacts puissants.
- Ne pas faire de soudure directement sur la batterie.
- Ne pas exposer la batterie à l'eau ou à l'eau salée ni à une grande humidité, et ne pas la laisser être mouillée.
- Ne pas démonter ni modifier la batterie. La batterie contient des dispositifs de sécurité et de protection qui, en cas de dommages, pourraient l'amener à chauffer, à exploser ou à prendre feu.
- Ne pas utiliser le module de circuit de protection offert avec les blocs-piles en remplacement d'un contacteur d'isolement.
- Ne pas mettre la batterie dans ou à proximité du feu, sur des cuisinières ou dans d'autres endroits à température élevée.
- Ne pas placer la batterie directement au soleil ni l'utiliser ou l'entreposer dans des voitures par temps chaud. Ceci pourrait l'amener à chauffer, à exploser ou à prendre feu. D'utiliser la batterie de cette manière peut également la rendre moins performante et diminuer son espérance de vie.
- Quand la batterie est usée, isoler les bornes à l'aide de ruban adhésif ou d'un matériau non conducteur semblable avant de la jeter.
- Cesser immédiatement l'utilisation de la batterie si, en cours d'utilisation ou de chargement ou lorsqu'elle est entreposée, elle émet une odeur inhabituelle, dégage de la chaleur, change de couleur ou de forme ou semble anormale de quelque autre manière que ce soit.

- Ne pas mettre la batterie dans des fours à micro-ondes, des contenants à haute pression ou des ustensiles de cuisine à induction.
- Garder les batteries hors de la portée des enfants.
- Toujours débrancher la batterie avant de l'entreposer ou de la transporter.
- Toujours entreposer la batterie dans un contenant étanche à l'épreuve des flammes loi de toute matière inflammable ou corrosive.



#### ATTENTION !

Si la batterie fuit et que le fluide entre en contact avec l'oeil de quelqu'un, ne pas frotter l'oeil. Bien rincer à l'eau et tout de suite demander des soins médicaux. Le fluide de la batterie risque de causer des dommages à l'oeil si celui-ci n'est pas traité.



#### ATTENTION !

Si le dispositif cause la circulation d'un courant anormal, il se peut que la batterie chauffe, explose ou prenne feu et cause ainsi des blessures graves.

### Types de chargeur

Votre batterie ne devrait être rechargée qu'à l'aide d'un chargeur recommandé par HME/Clear-Com. Toute tentative d'utiliser d'autres types de chargeurs risque d'entraîner une réaction explosive, un feu ou des brûlures chimiques. Ne pas présumer que la forme physique d'une autre batterie fait que le chargeur y correspondant peut être utilisé avec la batterie HME/Clear-Com.

### Chargement de la batterie

S'assurer de suivre les avertissements indiqués ci-dessous au moment de charger la batterie. La batterie pourrait sinon chauffer, exploser ou prendre feu et ainsi causer des blessures graves.

- Ne pas continuer à charger la batterie si elle ne se recharge pas de la manière indiquée dans le guide de l'utilisateur HME/Clear-Com, dans la section des directives de chargement.
- Ne pas brancher la batterie à un chargeur externe, à une prise d'alimentation ou directement dans l'allume-cigare d'une voiture.
- Toujours procéder à l'inspection visuelle de la batterie avant ou après son chargement.
- Toujours laisser la batterie refroidir à une température ambiante sécuritaire avant de la charger au terme de son cycle de décharge précédent.
- Ne pas recharger la batterie sur ou à proximité de matériaux inflammables; ceci fera en sorte qu'en cas de mauvais fonctionnement, elle puisse être contenue en causant le moins de dommages et de blessures possible.

### Recyclage de la batterie

Quand la batterie atteint la fin de sa vie utile, il devrait revenir à une entreprise de recyclage qualifiée ou à une entreprise de gestion des matériaux dangereux de s'en débarrasser. Ne pas mélanger cette batterie au courant de déchets solides.

Si votre entreprise ou votre foyer ne participe à aucun programme de recyclage des batteries, cliquez sur l'adresse URL suivante ou collez-la dans votre navigateur, puis entrez votre code postal en vue d'obtenir une liste de centres de recyclage : <http://earth911.com>

# INSTRUCCIONES GENERALES DE SEGURIDAD PARA BATERÍAS PARA CADA MODELO DE BATERÍA: BAT41, BAT50, BAT60

Las baterías BATXX están diseñadas específicamente para usarse solo con el(los) producto(s) que ofrezca:

HM Electronics Inc. (HME)

Clear-Com LLC, una compañía de HME

## PRECAUCIONES DE SEGURIDAD

Para garantizar la seguridad y la fiabilidad de su batería, siga las directrices en esta sección.

### Al usar la batería



#### **¡ADVERTENCIA!**

#### **No dañe ni modifique los empaques de las baterías**

Si las celdas de iones de litio y los empaques de las baterías se modifican o dañan, pueden recalentarse, explotar o incendiarse y causar heridas graves.

### **Siga las instrucciones de seguridad que se indican a continuación:**

- No exponga la batería al fuego ni la caliente.
- No conecte la batería al revés, de modo que la polaridad estuviera invertida.
- No conecte la terminal positiva con la negativa usando objetos metálicos (como un alambre).
- No almacene ni lleve las baterías junto con collares, horquillas u otros objetos metálicos.
- No perforo con clavos, golpee con martillo ni pise la batería, ni la someta de manera alguna a golpes fuertes.
- No suelde directamente sobre la batería.
- No exponga la batería al agua, sea dulce o salada, ni a la humedad alta, ni permita que se humedezca o se moje la batería.
- No desarme ni modifique la batería. La batería contiene dispositivos de seguridad y de protección que, si se dañan, pueden causar que la batería genere calor, explote o se incendie.
- El módulo de circuito de protección incluido en los empaques de las baterías no debe usarse como sustituto de un interruptor de apagado.
- No exponga la batería al fuego ni cerca de este, en estufas ni en lugares de altas temperaturas.
- No exponga la batería bajo la luz solar directa ni use o almacene la batería en un carro en climas calientes. Hacer lo anterior, podría generar que la batería genere calor, explote o se incendie. Asimismo, usar la batería de esta manera podría resultar en una pérdida de rendimiento o disminución de la expectativa de vida útil del equipo.
- Cuando la batería se desgaste, aisle las terminales con cinta adhesiva u otro material similar que no sea conductor, antes de deshacerse de ella.
- Deje de utilizar inmediatamente la batería si, mientras la usa, carga o almacena, esta emite un olor inusual, se siente caliente, cambia de color o forma o parece anormal de cualquier otra manera.

- No coloque la batería en hornos microondas, contenedores de alta presión ni en materiales de cocina inducida.
- Mantenga las baterías fuera del alcance de los niños.
- Desconecte siempre la batería antes de almacenarla o transportarla.
- Almacénela siempre en contenedores estrictamente resistentes al fuego lejos de materiales inflamables o corrosivos.



#### **¡ADVERTENCIA!**

En caso de que la batería gotee y le entre el fluido en los ojos, no se los restriegue. Enjuague bien con agua y busque asistencia médica inmediatamente. Si no recibe tratamiento, el fluido de la batería podría causarle daño en sus ojos.



#### **¡ADVERTENCIA!**

Si el dispositivo causa que fluya corriente anormal, puede causar que la batería se caliente, explote o se incendie y cause heridas graves.

### Tipos de cargador

Su batería debe cargarla únicamente con un cargador recomendado por HME/Clear-Com. Si intenta usar otro tipo de cargador, puede causar una reacción explosiva, incendio o quemaduras con sustancias químicas. No asuma que la forma física de otra batería permita que el cargador de esta puede usarse con la batería de HME/Clear-Com.

### Cargar la batería

Asegúrese de seguir las advertencias que se describen más abajo mientras carga su batería. Si no lo hace, puede causar que la batería se caliente, explote o se incendie y cause heridas graves.

- No siga cargando la batería, si no se recarga como se especifica en la guía para el usuario de HME/Clear-Com, según las instrucciones de carga.
- No conecte la batería a un cargador externo, conector de energía ni directamente al encendedor de cigarrillos de un carro.
- Inspeccione siempre visualmente su batería antes y después de cargarla.
- Deje siempre que su batería se enfríe hasta que esté en su temperatura ambiental segura antes de cargar, después de su ciclo anterior de descarga.
- No cargue las baterías sobre ningún tipo de material inflamable. Esto asegurará que, si hay una falla de funcionamiento, se pueda contener con la menor cantidad posible de daños y heridas.

### Reciclar la batería

Cuando la batería llegue al fin de su vida útil, un reciclador calificado o una persona encargada de manipular materiales peligrosos deberían encargarse de desecharla. No mezcle esta batería con el flujo de residuos sólidos.

Si su negocio u hogar no tiene un programa de reciclaje de baterías, vaya a la siguiente dirección URL o pegue la siguiente dirección en su navegador y, luego, introduzca su código postal para obtener una lista de los centros de reciclaje:

<http://earth911.com>



## 배터리 모델의 일반적인 배터리 안전 지침: BAT41, BAT50, BAT60

BATXX 배터리는 다음 회사에서 제공하는 제품과 함께 사용하도록 특별히 설계되었습니다:

HM Electronics Inc. (HME), Clear-Com LLC, HME Company

## 안전 주의사항

배터리의 안전과 신뢰성을 보장하려면 이 섹션의 지침을 따르십시오.

### 배터리 사용



#### 경고!

**배터리 팩을 개조하거나 과도하게 사용하지 마십시오.**

리튬 이온 셀 및 배터리 팩을 개조하거나 과도하게 사용하면 뜨거워지거나 폭발하거나 발화되어 심각한 부상을 입을 수 있습니다.

### 아래의 안전 지침을 따르십시오:

- 배터리를 불 속에 넣거나 가열하지 마십시오.
- 배터리를 거꾸로 연결하지 마십시오. 그러면 극성이 바뀌게 됩니다.
- 배터리의 양극 단자와 음극 단자를 금속 물체(전선 등)로 서로 연결하지 마십시오.
- 배터리를 목걸이, 머리카락 또는 기타 금속 물체와 함께 휴대하거나 보관하지 마십시오.
- 배터리를 손톱으로 흠집을 내거나, 망치로 두드리거나, 밟거나 강한 충격을 가하지 마십시오.
- 배터리에 직접 납땜하지 마십시오.
- 배터리를 물이나 바닷물 또는 높은 습도에 노출시키거나 젖지 않도록 하십시오.
- 배터리를 분해하거나 개조하지 마십시오. 배터리에는 안전 장치와 보호 장치가 포함되어 있고, 손상될 경우 배터리가 뜨거워지거나 폭발하거나 발화할 수 있습니다.
- 배터리 팩과 함께 제공되는 보호 회로 모듈은 차단 스위치의 대체품으로 사용되어서는 안 됩니다.
- 배터리를 화기 근처나 난로 위 또는 기타 고온이 발생하는 장소에 두지 마십시오.
- 배터리를 직사광선이 비치는 곳에 두거나 더운 날씨에 자동차 안에서 사용하거나 보관하지 마십시오. 그러면 배터리가 뜨거워지거나 폭발하거나 발화할 수 있습니다. 그러한 방식으로 배터리를 사용하면 성능이 저하되거나 예상 수명이 단축될 수 있습니다.
- 배터리를 다 쓴 후에 폐기하기 전에 단자를 접착 테이프 또는 이와 유사한 비전도성 재료로 절연 처리하십시오.
- 배터리를 사용, 충전하거나 보관하고 있는 동안, 배터리에서 이상한 냄새가 나거나 뜨거워지거나 색이나 모양이 변하거나 기타 비정상적인 상태를 보이면 즉시 사용을 중단하십시오.
- 전자레인지, 고압 용기 또는 인덕션 조리기구에 배터리를 넣지 마십시오.
- 배터리를 어린이의 손이 닿지 않는 곳에 두십시오.
- 배터리를 보관하거나 운반하기 전에 항상 분리하십시오.
- 항상 가연성 또는 부식성 물질이 없는 밀폐된 방염 용기 안에 배터리를 보관하십시오.



#### 경고!

배터리가 새어나와 액체가 눈에 들어가면 눈을 문지르지 마십시오.물로 잘 씻은 다음 즉시 병원으로 가십시오. 치료하지 않고 그대로 두면 배터리 액체로 인해 눈이 손상될 수 있습니다.



#### 경고!

기기에 비정상적인 전류가 흐를 경우, 배터리가 뜨거워지거나 폭발하거나 발화되어 심각한 부상을 입을 수 있습니다.

## 충전기 유형

이 배터리는 HME/Clear-Com 권장 충전기에서만 충전해야 합니다. 다른 유형의 충전기를 사용할 경우 폭발 위험이 있으며 화재나 화상을 입을 수 있습니다. HME/Clear-Com 배터리를 충전기를 다른 형태의 배터리에도 사용할 수 있다고 가정하지 마십시오.

## 배터리 충전

배터리를 충전하는 동안 아래 명시된 경고를 따르십시오. 그렇지 않으면 배터리가 뜨거워지거나 폭발하거나 발화되어 심각한 부상을 입을 수 있습니다.

- HME/Clear-Com 사용 설명서의 충전 지침에 나오는 대로 충전되지 않으면 배터리를 계속 충전하지 마십시오.
- 배터리를 외부 충전기, 전원 플러그 또는 자동차의 시가 라이터에 직접 연결하지 마십시오.
- 충전하기 전과 충전한 후에 항상 배터리를 육안으로 점검하십시오.
- 방전 사이클을 거친 후 배터리를 충전하기 전에 항상 안전한 주변 온도에 맞게 식히십시오.
- 가연성 물질이 있는 곳이나 근처에서 배터리를 충전하지 마십시오. 그러면 오작동이 발생할 경우 손상이나 부상 가능성을 최소화할 수 있습니다.

## 배터리 재활용

배터리의 수명이 다하면 유자격 재활용 업체나 위험 물질 취급업체를 통해 다 쓴 배터리를 폐기 처리해야 합니다. 이 배터리가 일반 쓰레기와 함께 섞이지 않도록 하십시오.

회사나 주거지에 배터리 재활용 프로그램이 없는 경우, 다음 URL로 이동하거나 브라우저에 URL을 복사하여 붙여넣고, 재활용 센터 목록의 우편번호를 입력하십시오: <http://earth911.com>



有毒有害物质或元素表

Table of Toxic and Hazardous Substances

部件名称 Names of Parts	有毒有害物质或元素 Toxic and Hazardous Substances or Elements					
	铅 Pb	镉 Cd	汞 Hg	六价铬 Cr6+	多溴联苯 PBB	多溴二苯醚 PBDE
BS210 基站 Top assembly BS210 (G28707-1A1)	X	O	O	O	O	O
基站电路板 Audio PCB (G28718-1)	X	O	O	O	O	O
收发器电路板 Front Panel PCB (G28729-1)	X	O	O	O	O	O
收发器电路板 XCVR PCB (G27739-4A1)	X	O	O	O	O	O
AC40 电池充电器 AC40 (G27368)	X	O	O	O	O	O
电源器 (453G008) CCC P/S	X	O	O	O	O	O

**O:** 表示该有毒有害物质在该部件所有均质材料中的含量均在SJ/T11363-2006标准规定的限量要求以下。

**O: Indicates that this toxic or hazardous substance contained in all of the homogeneous materials for this part is below the limit requirements in SJ/T11363-2006**

**X:** 该有毒有害物质至少在该部件的某一均质材料中的含量超出SJ/T11363-2006标准规定的限量要求。

**X: Indicates that this toxic or hazardous substance contained in at least one of the homogeneous materials used for this part is above the limit requirements in SJ/T11363-2006**



表的有毒有害物质

**Table of Toxic and Hazardous Substances**

部件名称 <b>Names of Parts</b>	有毒有害物质或元素 <b>Toxic and Hazardous Substances or Elements</b>					
	铅 <b>Pb</b>	镉 <b>Cd</b>	汞 <b>Hg</b>	六价铬 <b>Cr6+</b>	多溴联苯 <b>PBB</b>	多溴二苯醚 <b>PBDE</b>
WH210 头戴式耳麦  Top Assembly WH210 (G28741-1Z1)	X	○	○	○	○	○
耳机电路板  PCB (G28055-1F1)	X	○	○	○	○	○
电池  Battery (104034)	○	○	○	○	○	○
<p><b>O:</b> 表示该有毒有害物质在该部件所有均质材料中的含量均在SJ/T11363-2006标准规定的限量要求以下。</p> <p><b>O: Indicates that this toxic or hazardous substance contained in all of the homogeneous materials for this part is below the limit requirements in SJ/T11363-2006</b></p> <p><b>X:</b> 该有毒有害物质至少在该部件的某一均质材料中的含量超出SJ/T11363-2006标准规定的限量要求。</p> <p><b>X: Indicates that this toxic or hazardous substance contained in at least one of the homogeneous materials used for this part is above the limit requirements in SJ/T11363-2006</b></p>						



有毒有害物质或元素表

Table of Toxic and Hazardous Substances

部件名称 <b>Names of Parts</b>	有毒有害物质或元素 <b>Toxic and Hazardous Substances or Elements</b>					
	铅 <b>Pb</b>	镉 <b>Cd</b>	汞 <b>Hg</b>	六价铬 <b>Cr6+</b>	多溴联苯 <b>PBB</b>	多溴二苯醚 <b>PBDE</b>
BP210 对讲机 Top Assembly BP210 (G27830-1A1)	X	O	O	O	O	O
对讲机电路板 XCVR PCB (G27560-1H1)	X	O	O	O	O	O
HS15 耳机 HS15/D Headset (306G100-1 /306G101-1)	X	O	O	O	O	O
对讲机套 Pouch (107G065)	X	O	O	O	O	O
电池 Battery (104034)	O	O	O	O	O	O
<p><b>O:</b> 表示该有毒有害物质在该部件所有均质材料中的含量均在SJ/T11363-2006标准规定的限量要求以下。</p> <p><b>O: Indicates that this toxic or hazardous substance contained in all of the homogeneous materials for this part is below the limit requirements in SJ/T11363-2006</b></p> <p><b>X:</b> 该有毒有害物质至少在该部件的某一均质材料中的含量超出SJ/T11363-2006标准规定的限量要求。</p> <p><b>X: Indicates that this toxic or hazardous substance contained in at least one of the homogeneous materials used for this part is above the limit requirements in SJ/T11363-2006</b></p>						